

XC3000Pro Vi si on

XC3000Pro Vi si on Laser Cutti ng System Commi ssi oni ng Manual



!

RAYTOOLS

XC3000Pro Vi si on

V1.0.1

2025

EMC

1) 

2) 
2)

1)
2)
3)
4)

1.
 - 1.1.
 - 1.2
 - 1.3
 - 1.4
 - 1.5
 - 1.6
 - 1.7.
2.
 - 2.1. EPC-1020
 - 2.1.1. EPC-1020
 - 2.2 EPC-2000
 - 2.3 EPC-2000
 - 2.4. EDS3000
 - 2.4.1. EDS3000
 - 2.4.2
 - 2.4.3
 - 2.4.4
 - 2.4.5
 - 2.4.6
 - 2.4.7. PWM
 - 2.4.8
 - 2.5
 - 2.6
 - 2.6.1. MAX
 - 2.6.2
 - 2.6.3 RFL-C3000
 - 2.7. EDS2011
 - 2.7.1. EDS2011
 - 2.7.2 EDS2011
 - 2.7.3 EDS2011
 - 2.7.4. EDS2011
 - 2.8. EDS2010
 - 2.8.1. EDS2010
 - 2.8.2 EDS2010
 - 2.8.3 EDS2010
 - 2.8.4. EDS2010
 - 2.9.
3.
 - 3.1.
 - 3.2
 - 3.2.1.
 - 3.2.2
 - 3.2.3
 - 3.2.4
 - 3.2.5
 - 3.2.6
 - 3.3

4.

4.1.

- 1 XY
- 2 XY
- 3 Z
- 4
- 5
- 6
- 7

4.2

4.3

5.

5.1.

- 5.1.1.
- 5.1.2 PLC
- 5.1.3
- 5.1.4
- 5.1.5 PLC
- 5.1.6 PLC
- 5.1.7.
- 5.1.8

5.2

- 5.2.1.
- 5.2.2
- 5.2.3

5.3

6.

6.1.

- 6.1.1.
- 6.1.2

6.2 F

- 6.2.1. BMØ
- 6.2.2 BM11

6.3

- 6.3.1.
- 6.3.2
- 6.3.3

OP

7.

7.1. EDS2000

- 7.1.1. EDS2000 /O
- 7.1.2 EDS2000
- 7.1.3 EDS2000
- 7.1.4 EDS2000
- 7.1.5 EDS2000

7.2 EDS3000

7.3 EDS2011

7.4 EDS2010

7.5 EPC-2000

7.6 EPC-1020

7.7. I PC E4000

7.8

7.9

7.9.1. XY

7.9.2

7.9.3. XY

7.9.4. Z

7.9.5

7.9.6

7.9.7.

7.9.8

7.9.9.

7.9.10

7.9.11.

7.9.12

7.9.13

7.9.14.

7.9.15

7.9.16

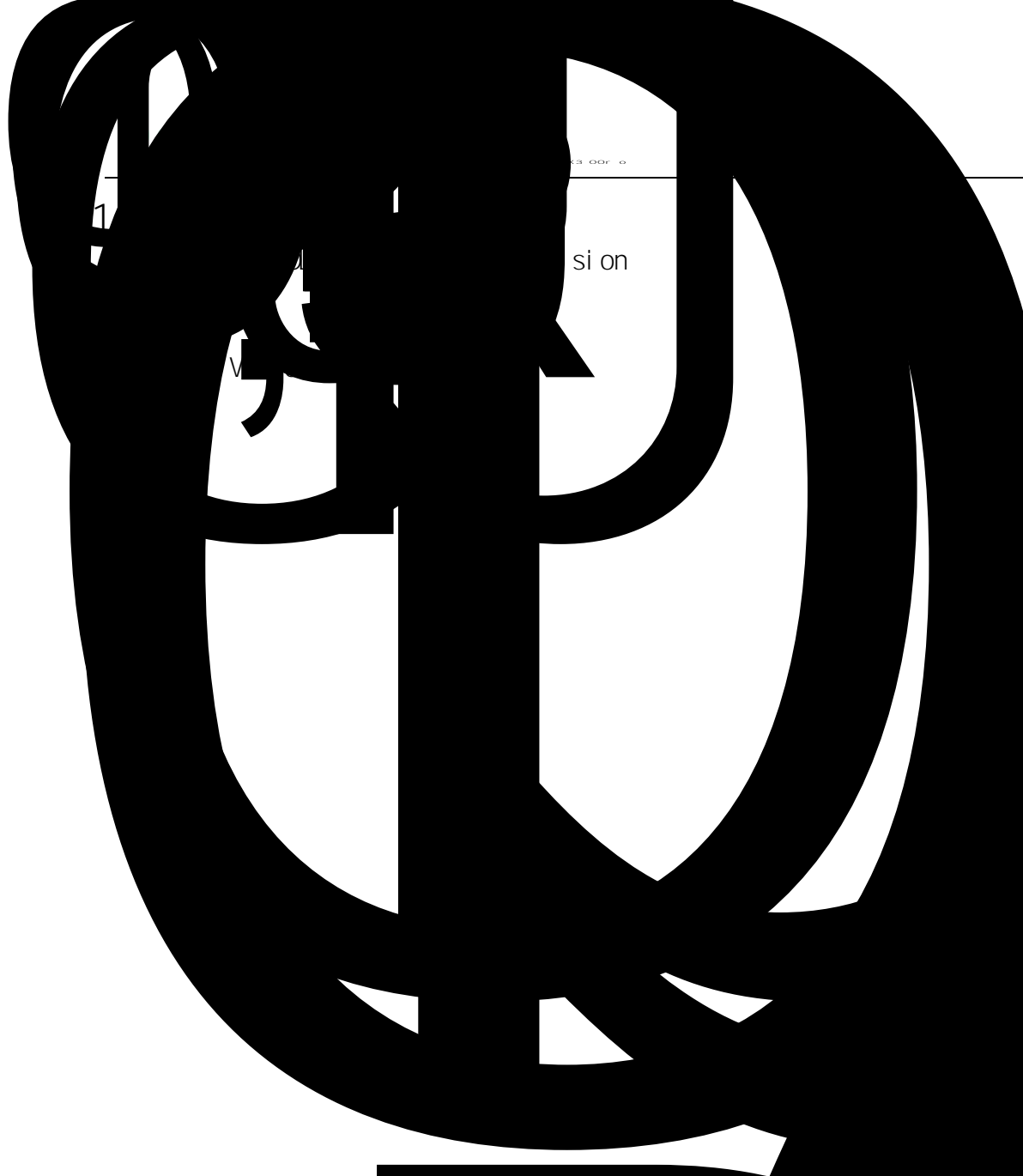

si on

si on

- ix

R



7



10

1

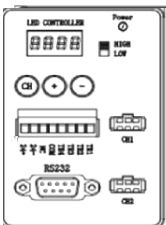

网络连接示意图

Schematic Diagram of EtherNET Connection

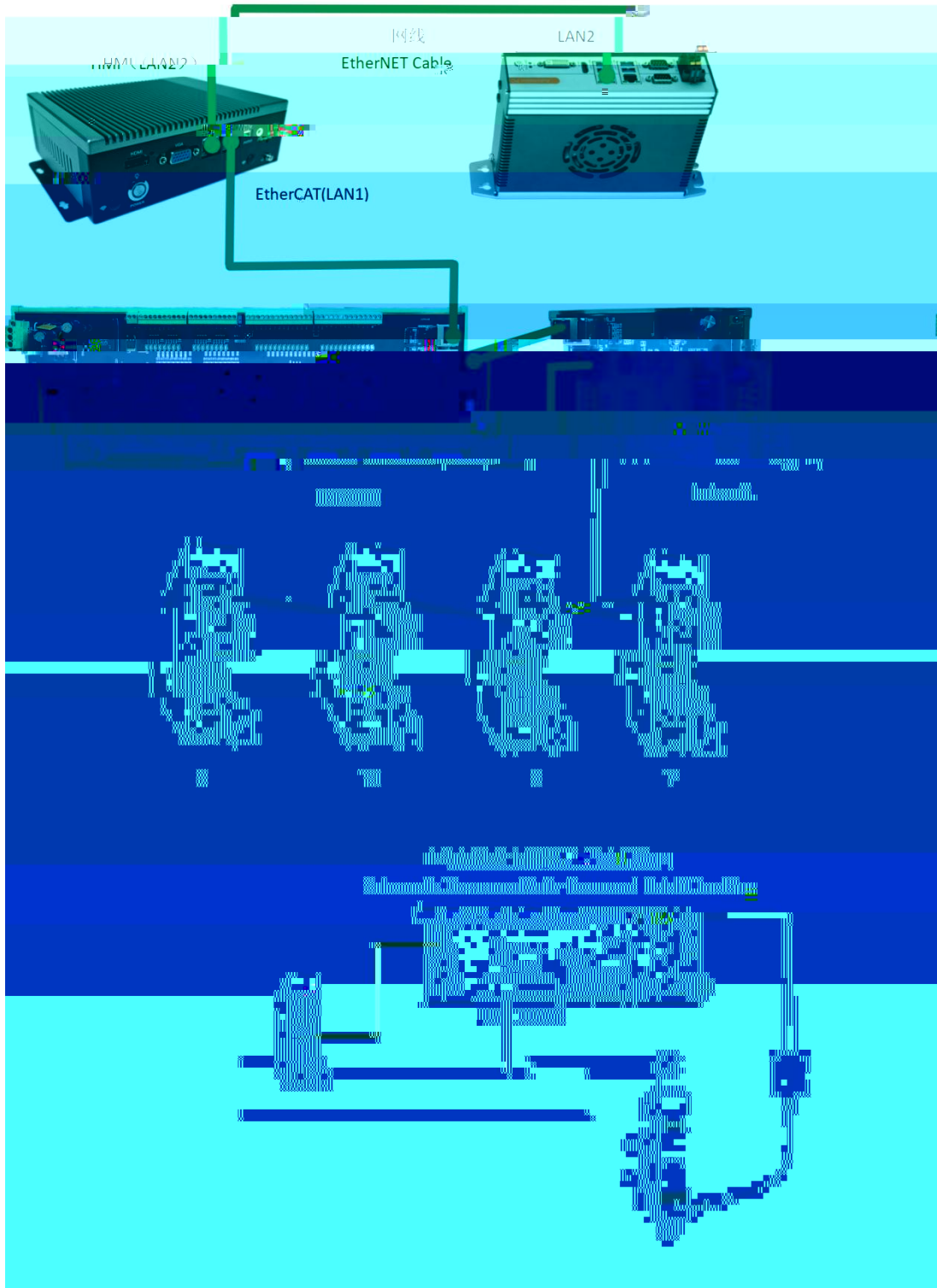

网络连接示意图

Schematic Diagram of FiberNET Connection



RAYTOOLS

		6.0MP
TV	(%)	0.1(0.003)
	(mm)	M80.5×0.5
	(mm)	37.0×56.0
	()	-10~+50
	(g)	104.5g

1.6

a

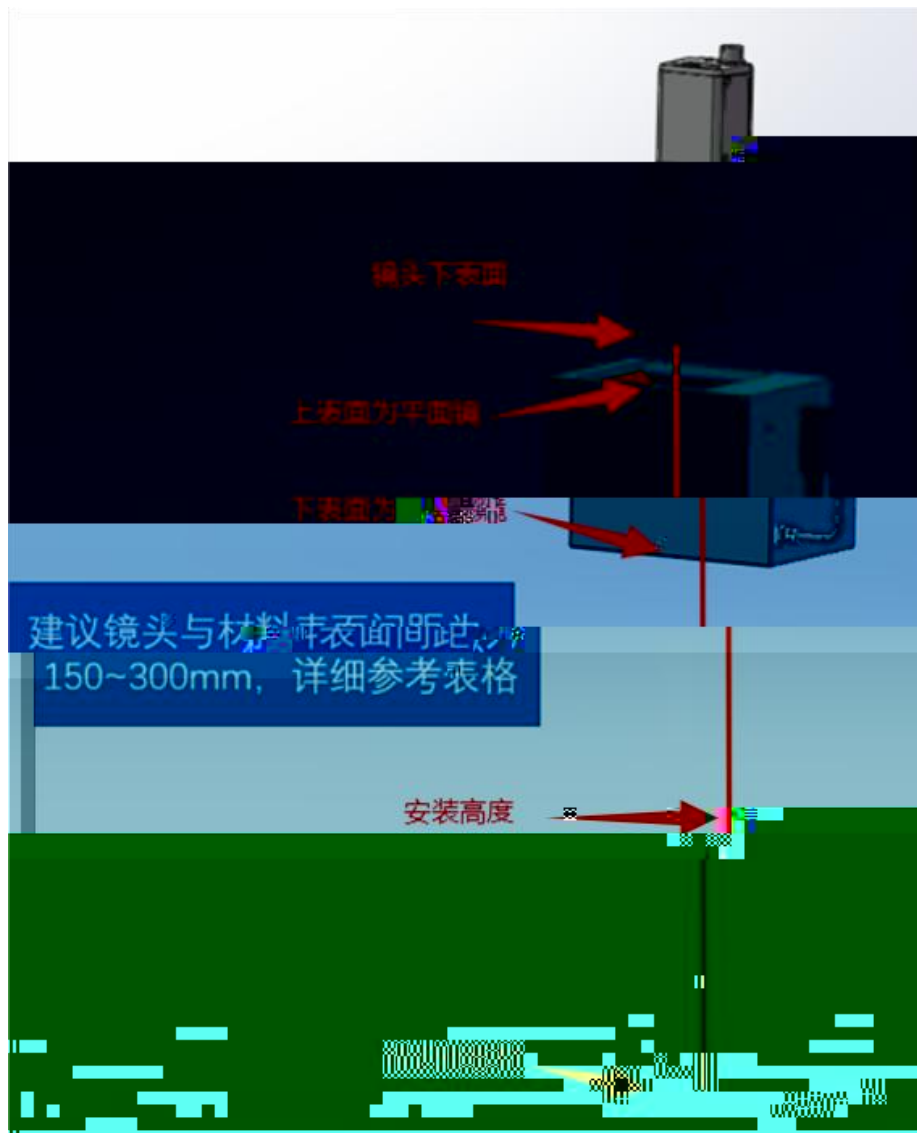

b

+

f	H	
---	---	--

RAYTOOLS

50mm	300mm	44.24mm*29.49mm
50mm+5mm =55mm	200mm	26.81mm*17.87mm
	150mm	20.10mm*13.41mm
50mm+10mm =60mm	200mm	24.57mm*16.38mm
	150mm	18.42mm*12.28mm
50mm+15mm =65mm	200mm	22.68mm*15.12mm
	150mm	17.01mm*11.34mm

1.7.



	A	B	
	C	C	

2.1.1. EPC-1020

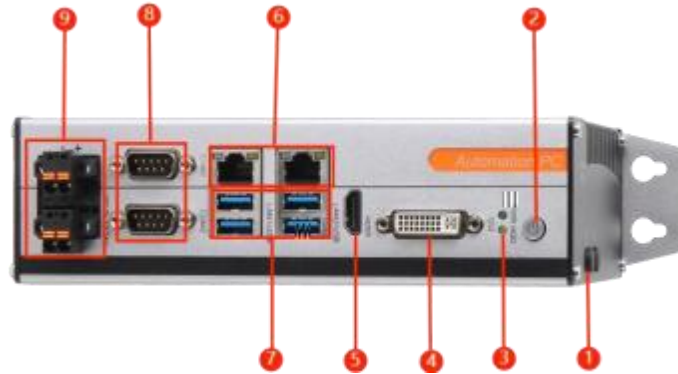

1	
2	
3	
4	DVI - D
5	HDMI
6	2 ×
7	4 × USB
8	2xRS232/RS485
9	DC I N 12V~24V

➤ LAN2 EPC-2000

➤ 24V 12V~24V

2.2 EPC-2000

EPC-2000 PC

RAYTOOLS

30A

EPC-2000	
	2 ×
USB	4 × USB2.0 2 USB3.0
	1 × 2.5HD, 1 × SATA
	-20 ~60
	5%-95%
	HDMI VGA
	9-36V
	× × 181.7 × 126.5 × 54mm

2.3. EPC-2000

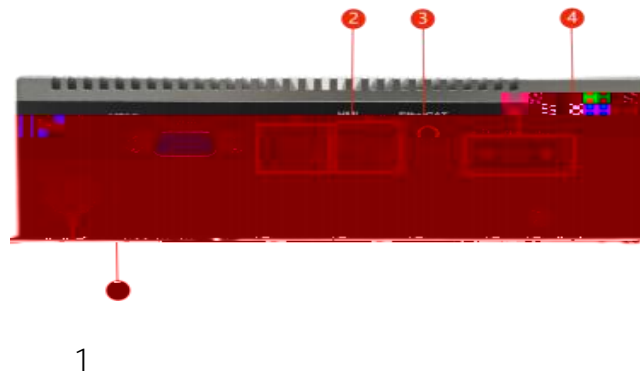

- EtherCAT LAN1 EtherCAT EDS
- HMI LAN2 EPC-1010
- 24V 9-36V

2.4. EDS3000

EDS3000 EtherCAT I O

EDS3000

	/	24V DC			18~36V
PWM	2	5V 24V	0% 100%	20kHz	
DA	4	0~ +10V	16bi t	10mV	
AD	4	0~ #10V 1	16bi t	10mV	
	24	24V/0V	00%	T	

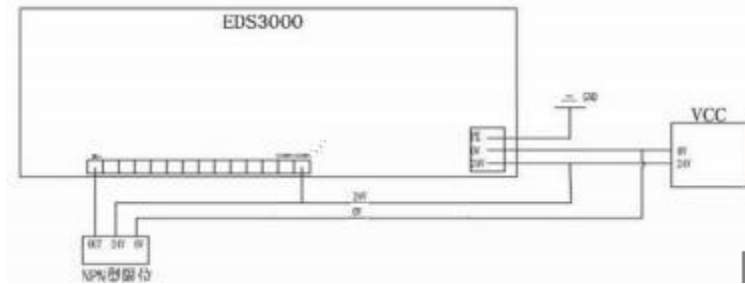

PNP

COM

OV

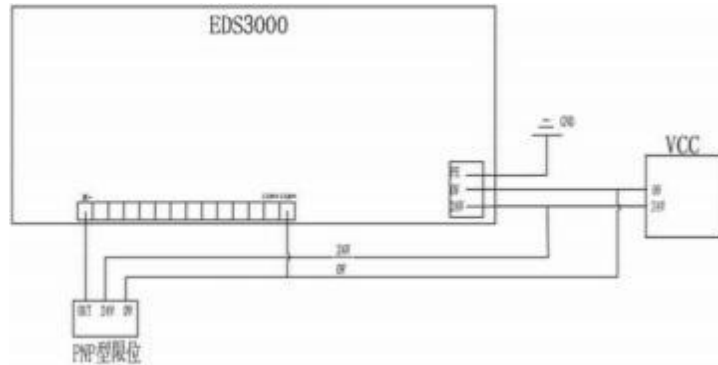

COM

24V

COM

OV

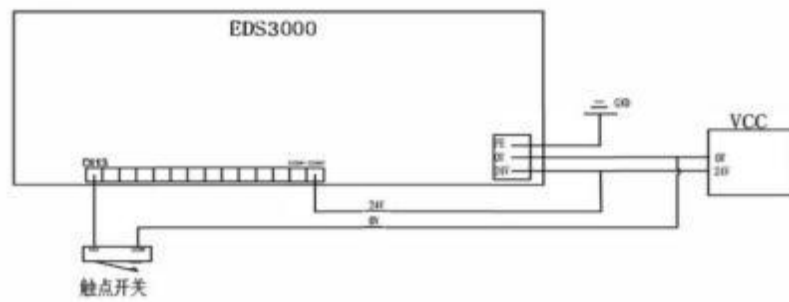

触点开关

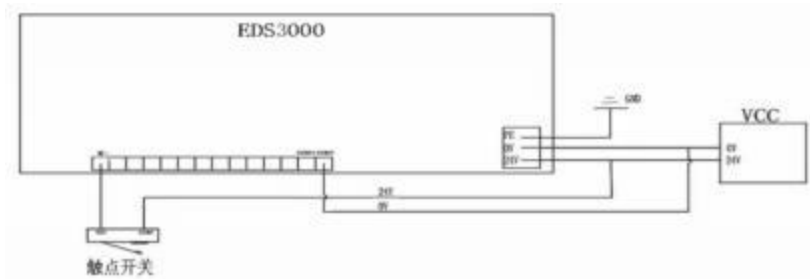

触点开关

2 4 4.

DO1 - DO16

16

24V

" " "

" " " " "

DO1~DO16

24V

0.5A

MIC 10A6

DC24V2

I/O

DC24V1

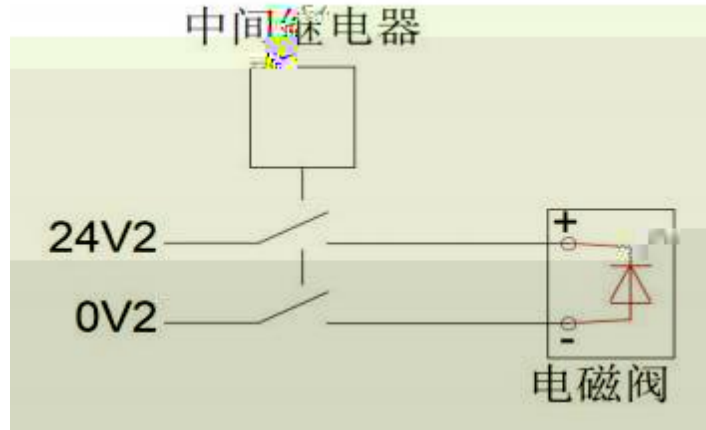

2.4.5

AI

4

0~10V

2.4.6

AO

4

0~10V



2.4.7

PWM

2 PWM

PWM

24V

5V

0%~100%

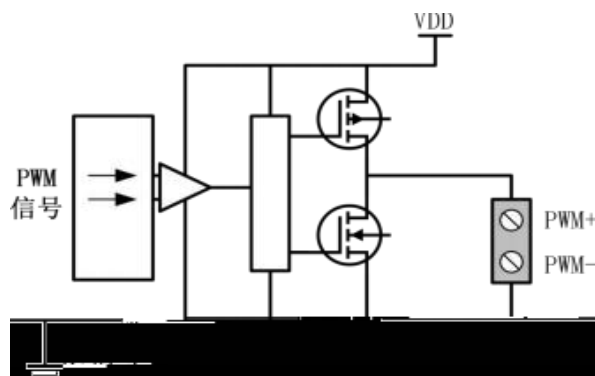



EDS3000 ALM

2

EDS3000 + SON

2.5.1.

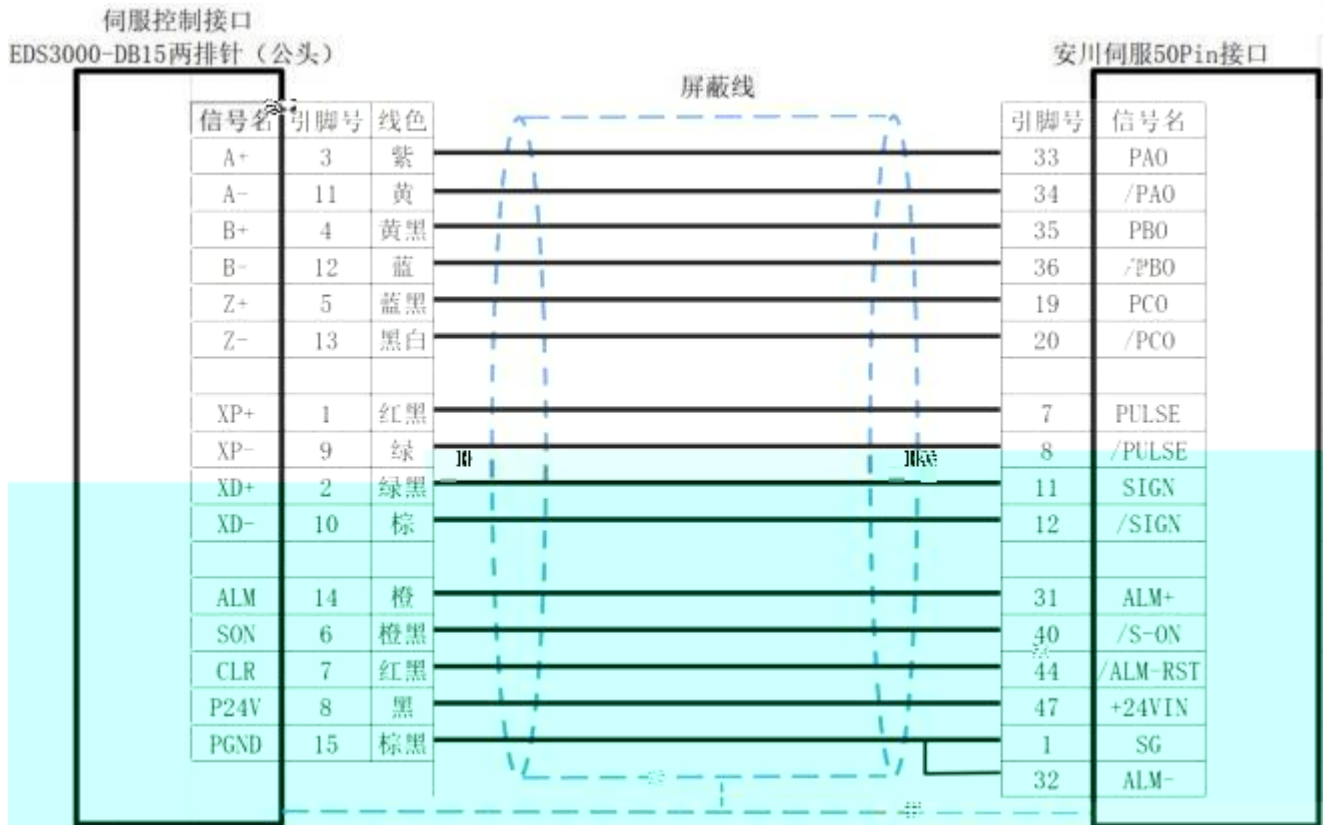

RAYTOOLS

Ph000 0.0.1.0 0.0.x.0(0 1)0.0.0.X(0 1)

Ph00B 0.1.0.1 0.X.0.0(0 1) 0.0.0.X(0 1

Ph200 0.0.0.0

3555

00

00

00

P00-07	0	0 + 1 ---
P00-16	1	0 1

2.5.3



Pr001	0	0 1:
Pr007	3	3
Pr005	1	1: 3mpa; 0: 500kpps

2.5.4

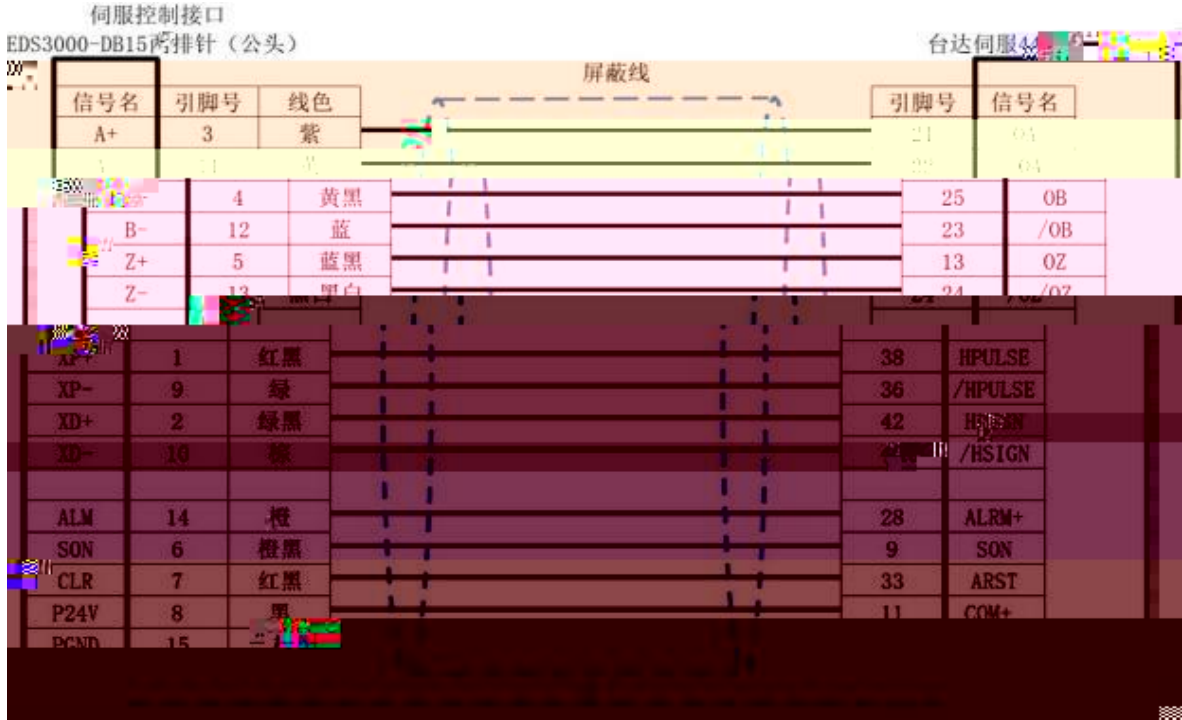

B

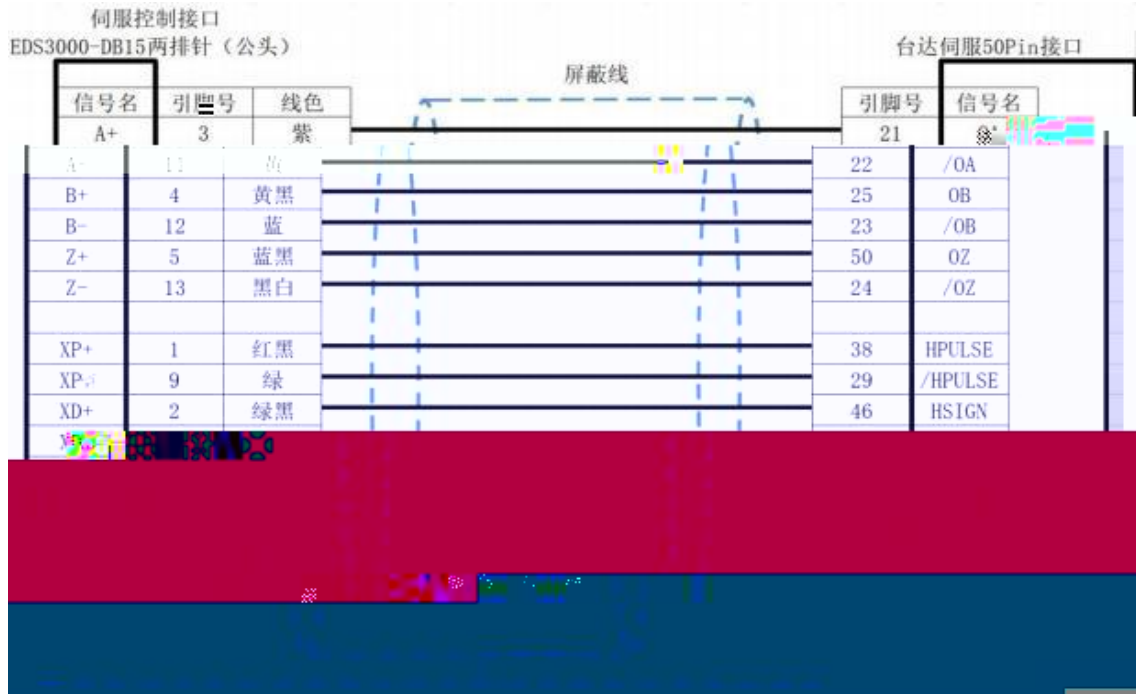

A2



P1-00	0x1002	1
P1-01	0x0000	1
P2-10	0x0101	DI 1

2 5 5

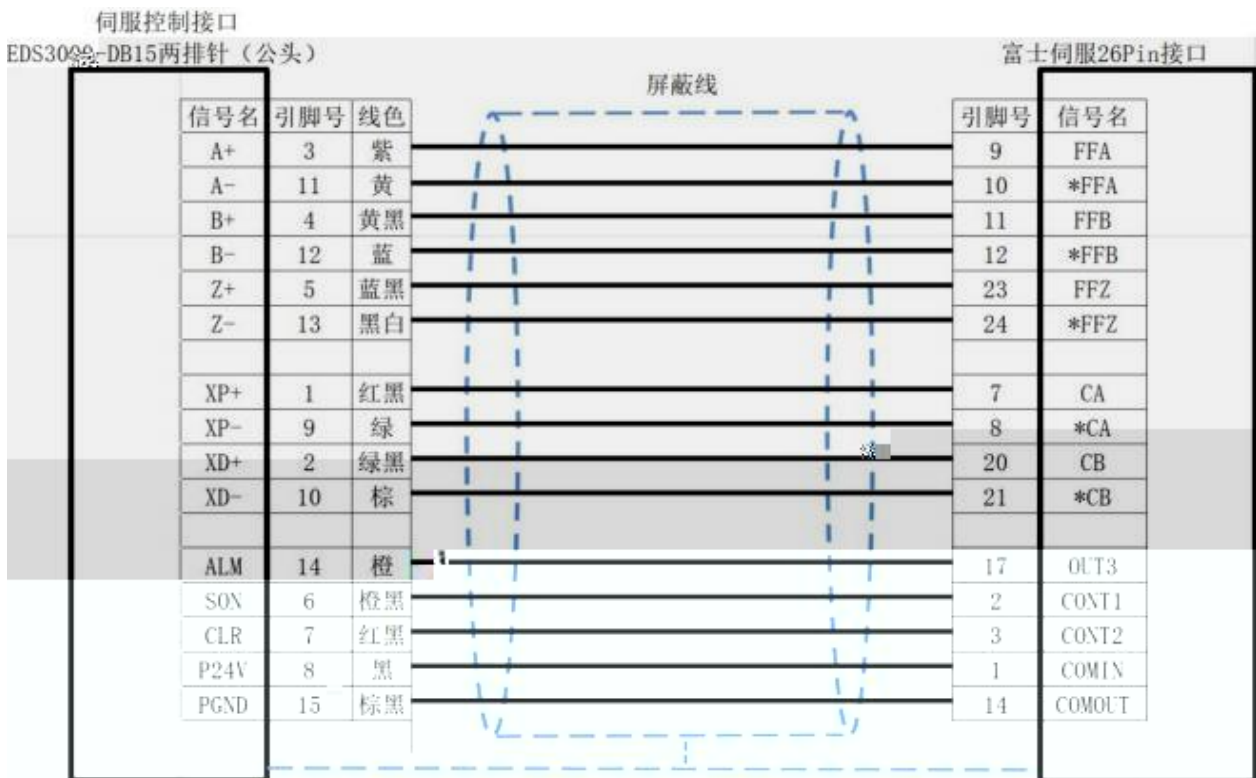

PA-101	0	0... 1... 2... 3... <=> 4... <=> 5... <=> 6... 7...
--------	---	--

PA-103	1	0... : / 1... :
		/ 2... : 90° 2 10... :
		: / 11... :
		/ 12... : 90° 2

2.5.6



P

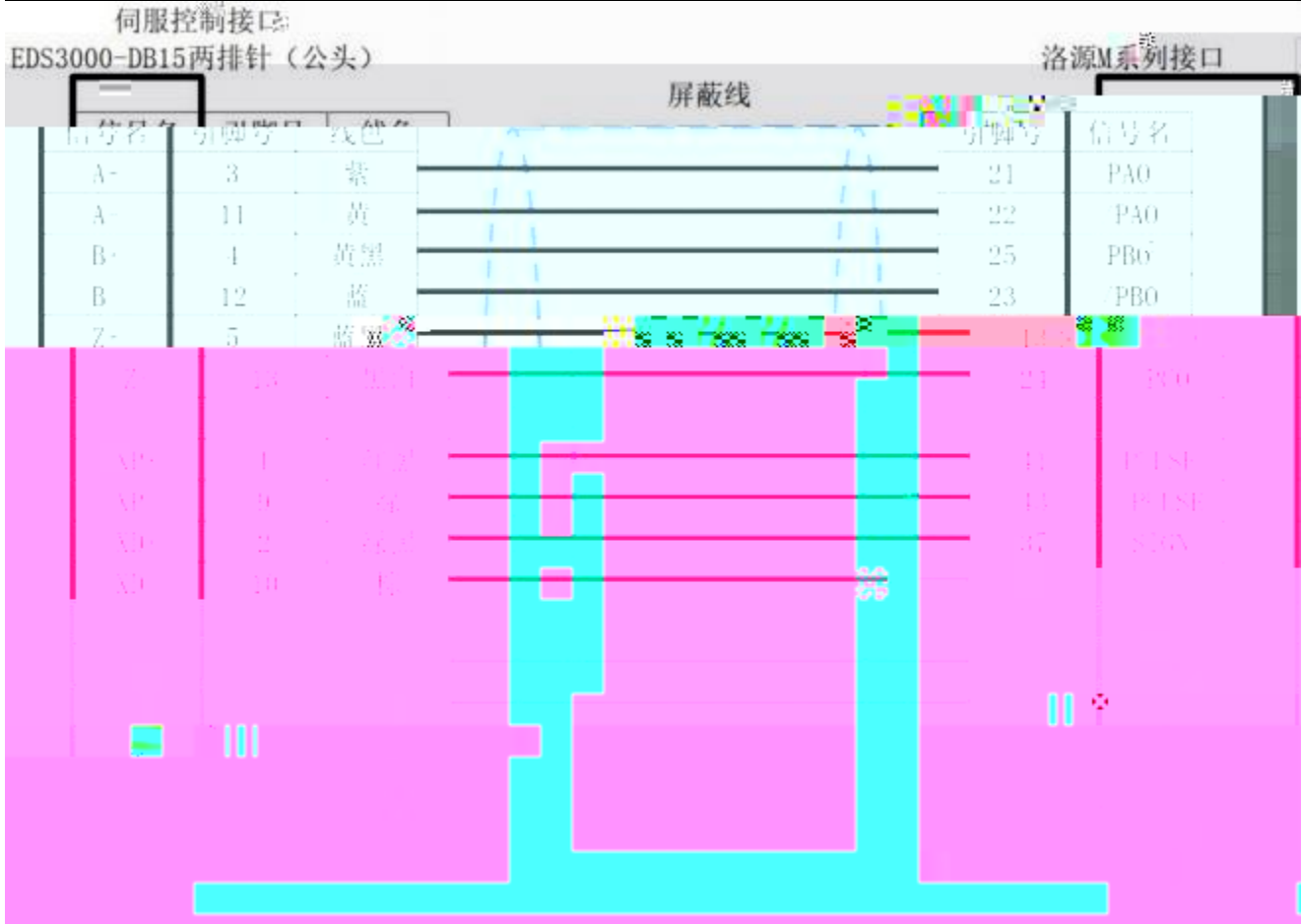

M

2.6

2.6.1. MAX

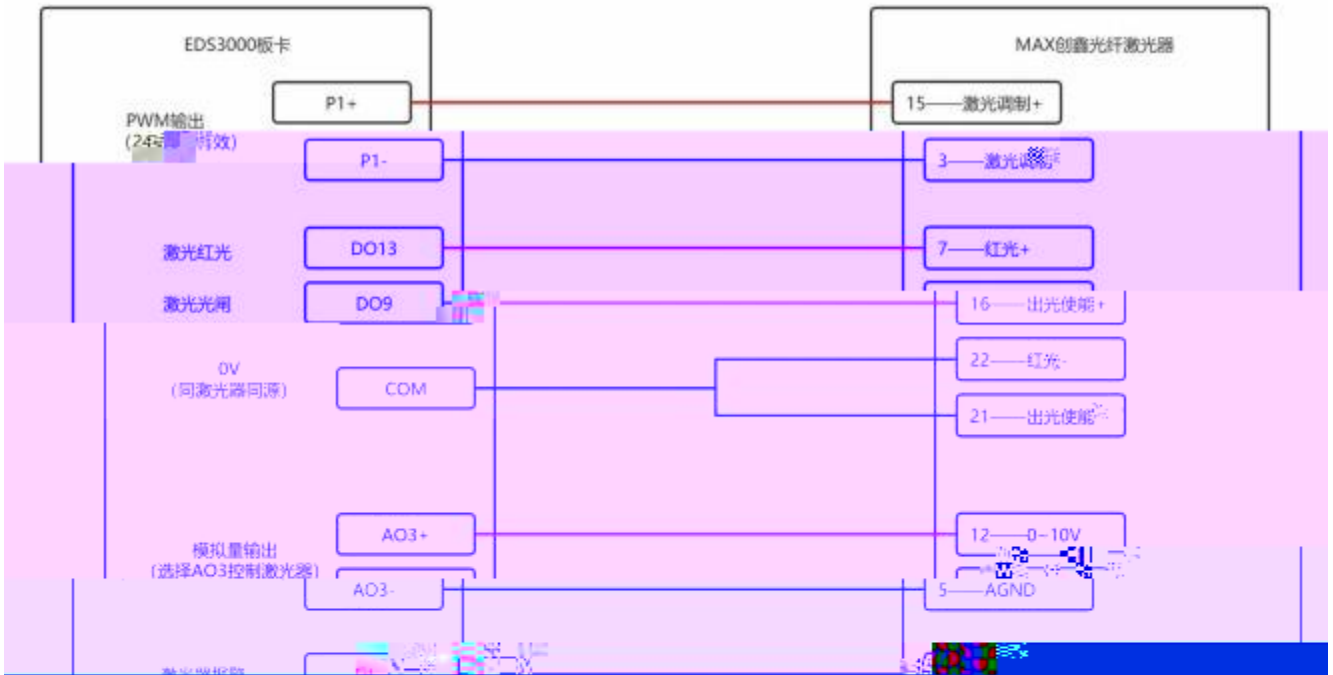

MAX 光纤激光器控制接线图

1. 激光器控制信号线：P1+ (PWM 输出) 接 MAX 激光器的 15 号端子 (激光调制+)。P1- 接 MAX 激光器的 3 号端子 (激光调制)。

2. 激光器红光信号线：DO13 (激光红光) 接 MAX 激光器的 7 号端子 (红光+)。

3. 激光器光闸信号线：DO9 (激光光闸) 接 MAX 激光器的 16 号端子 (出光使能+)。

4. 激光器 0V 信号线：COM (同激光器同零) 接 MAX 激光器的 22 号端子 (红光-)。

5. 激光器模拟量输出信号线：AO3+ (模拟量输出, 选择 AO3 控制激光器) 接 MAX 激光器的 12 号端子 (0-10V)。

6. 激光器模拟量输出信号线：AO3- 接 MAX 激光器的 5 号端子 (AGND)。

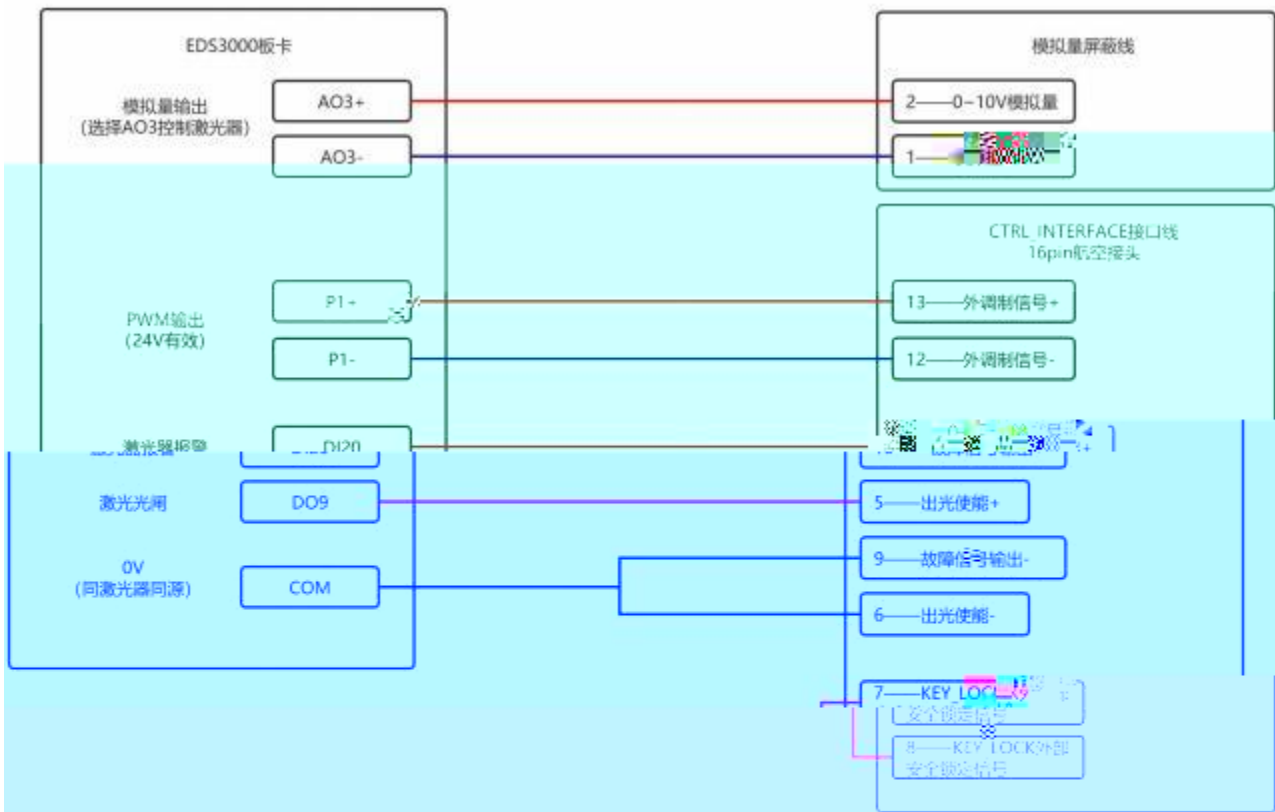

注:

1. DI20 是激光器报警输出点，接到EDS3000端子板的DI0输入点，“平台配置——数字量输入——DI20”默认报警  报警信号输出。

2. 激光光闸和激光报警信号可以接到EDS3000 端子板任意IO点，默认与激光器同电源。

3. 激光光闸线 19号 选择 2号 线束。

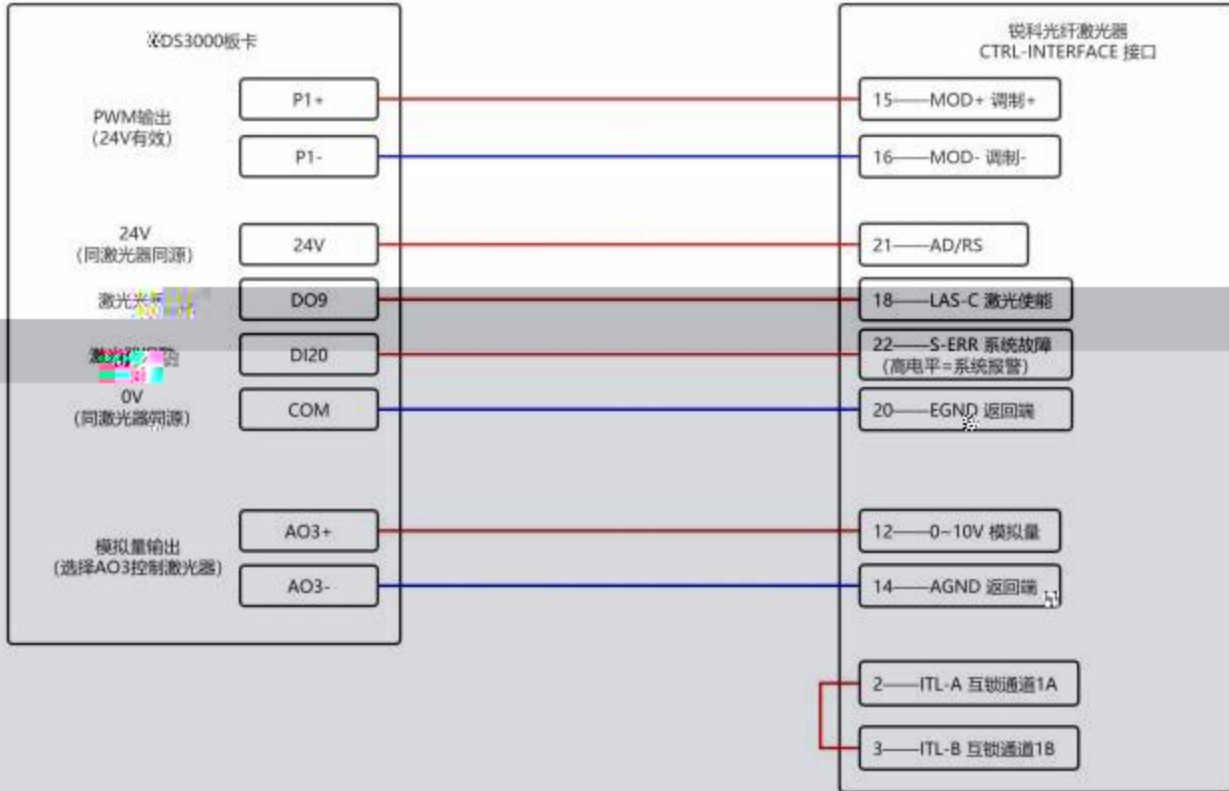

注:

1. RFL-C3000



2.7. EDS2011

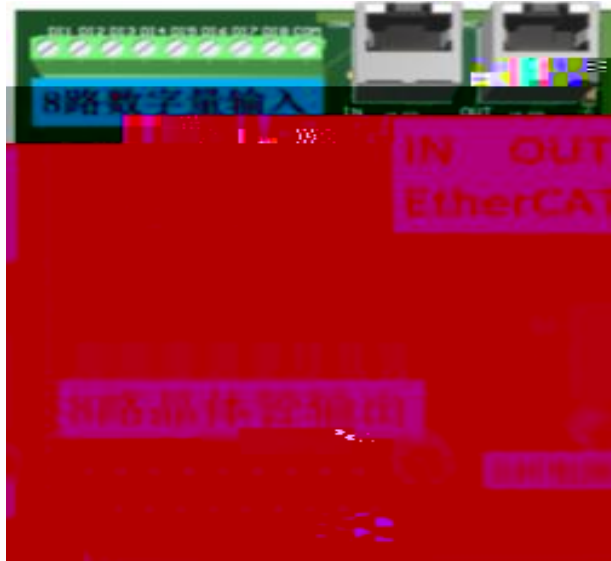

105mm*130mm

DI N C4535

RJ45	EtherCAT	EtherCAT IN	EtherCAT OUT
8	8	1-8	
	24V		

2.7.1. EDS2011

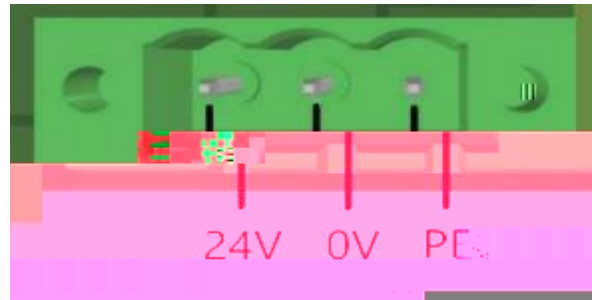

EDS2011	24V	0V	DC24V	24V	0V	PE
---------	-----	----	-------	-----	----	----

2.7.2. EDS2011

DI	8	COM	24V	COM	0V
----	---	-----	-----	-----	----

2.7.3. EDS2011

DO1-DO8	8	750mA	8	24V
---------	---	-------	---	-----



2.7.4 EDS2011

2.6.2 Q n



	RJ45	Ether CAT	Ether CAT IN	Ether CAT OUT
16	16	1	16	COM
		24V		24V

2.8.1. EDS2010

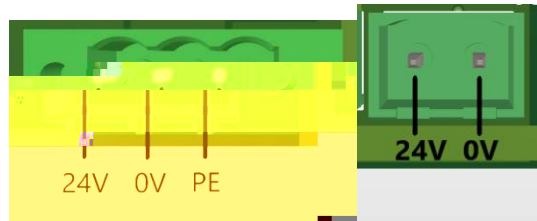

EDS2010	DC24V	24V 0V	24V 0V	24V 0V PE
		24V 0V		24V 0V

2.8.2. EDS2010

DI	16	DI 1-DI 16	COM 24V
COM 0V			

2.8.3. EDS2010

DO1-DO16	16	750mA	16	24V
----------	----	-------	----	-----

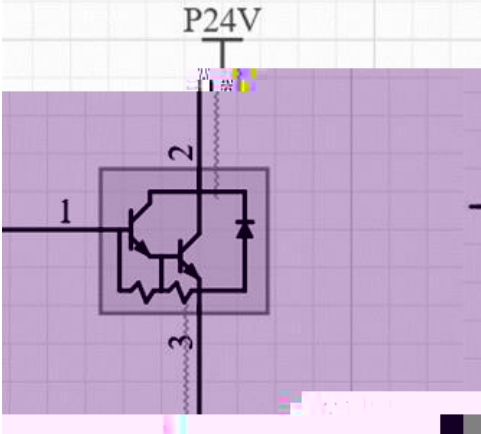

2.8.4. EDS2010

2.7.2

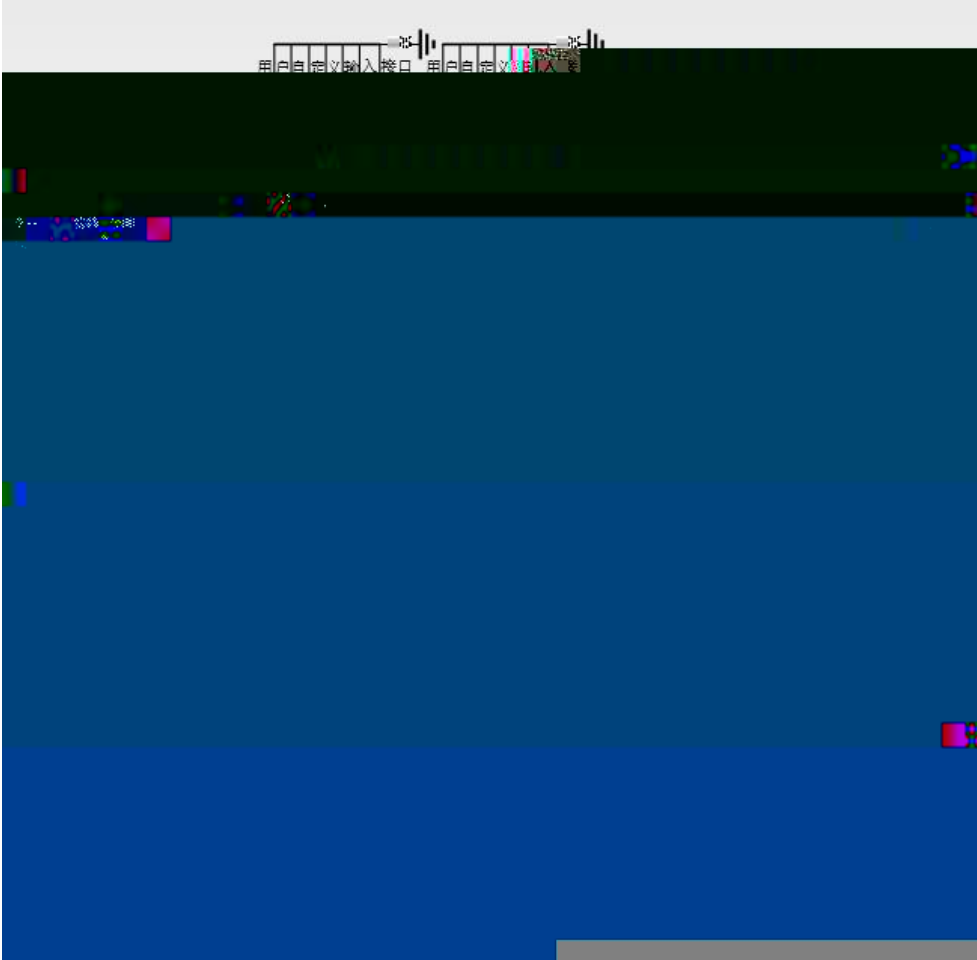

2.9.

1



2

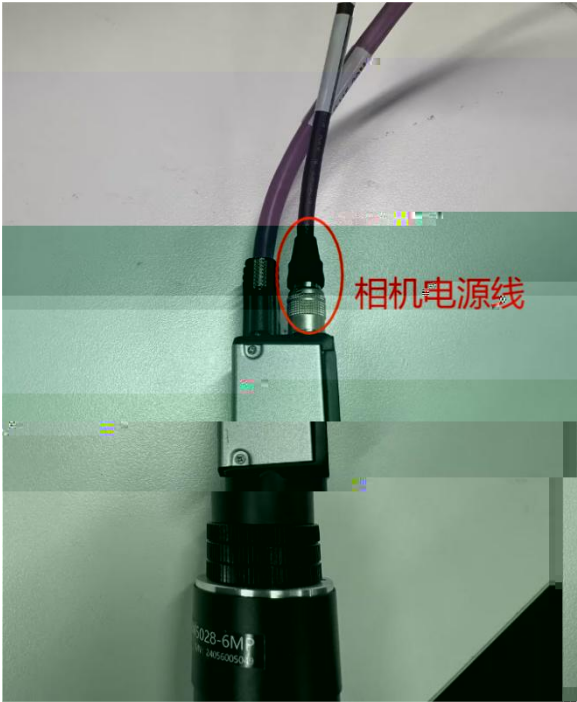

3

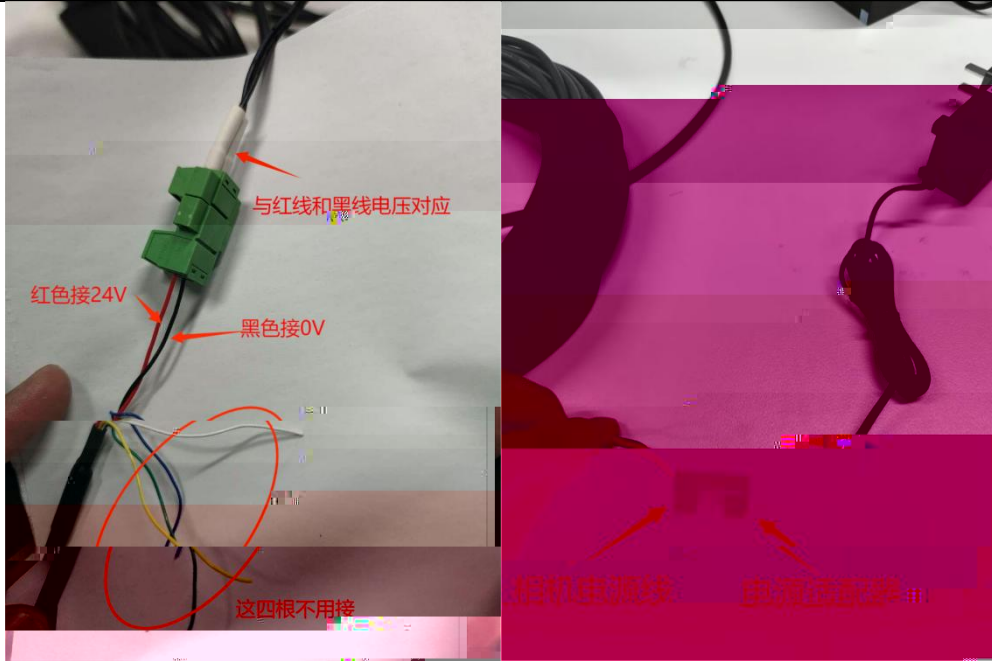

4

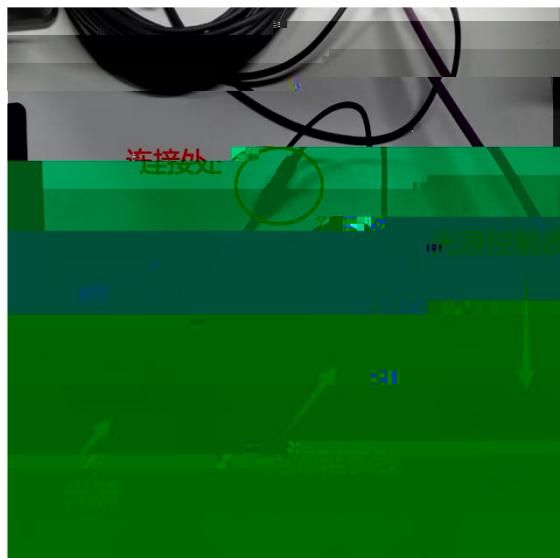

5

CH1



6

24V

+24V

- 24V



3.

3.1.

CPU	Inter i5 1.6GHz 4
	8GB
	120G
	2 × 10/100/1000
USB	4 × USB3.0 4 × USB2.0
	HDMI VGA
	Windows 10 64 / Windows 7 64

3.2

3.2.1.

1



2

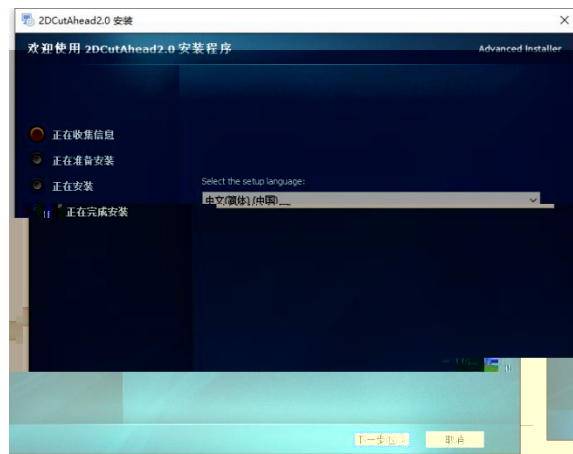

3

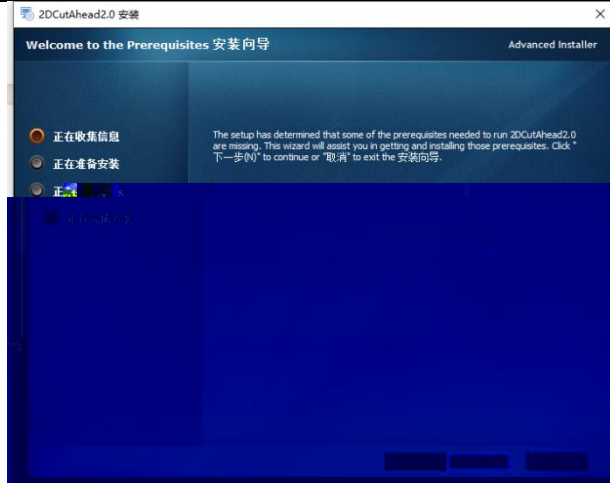

4

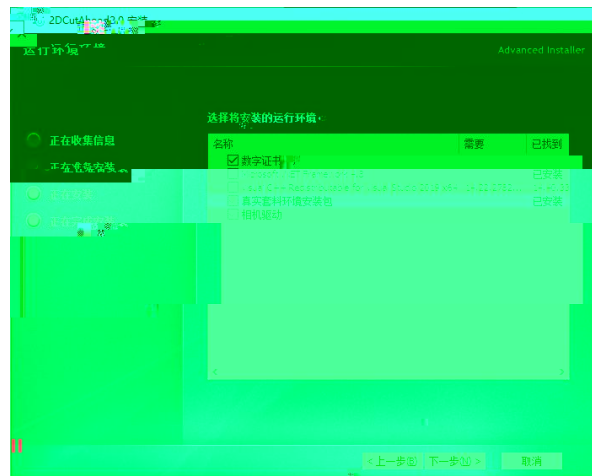

5

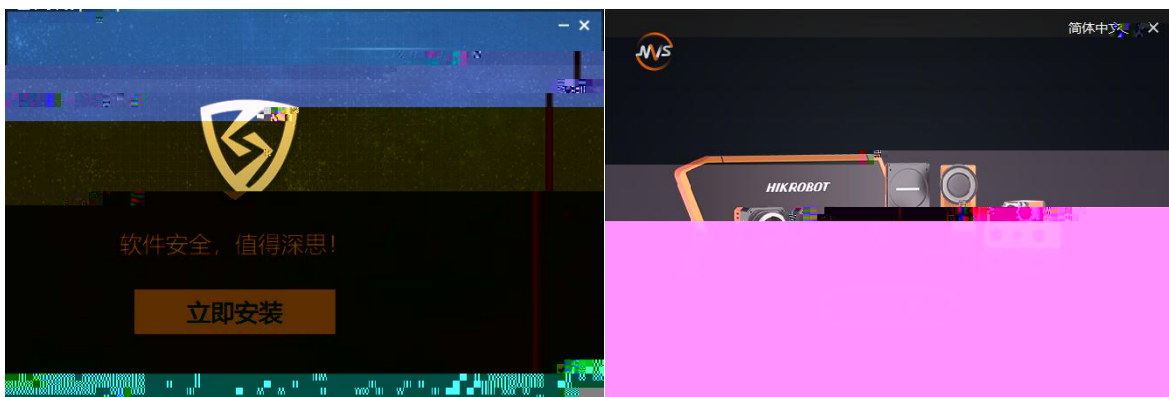

6

C. /HM



7



8

lpv

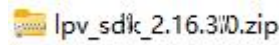

\\pv_sdk_2.16.3\O\bin
lpv

reg_run_as_admin

3.2.2

1

XC3000S

1

EDS3000

2



2



RAYTOOLS

3.2.3

XYZ

" "

3.2.4

1



2

"

HM"



3.2.5



3.2.6

a

ip

MWS



ip

ip

ip

ip

ip

ip

RAYTOOLS

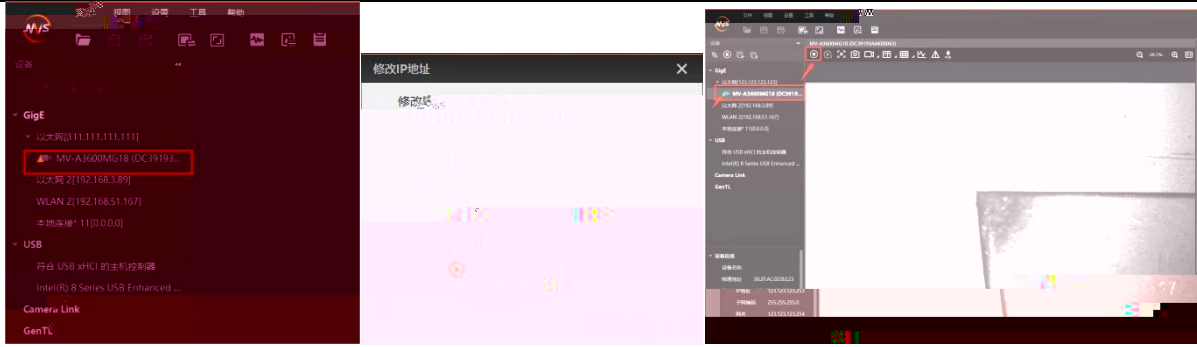

b



c

d

X

X

Y

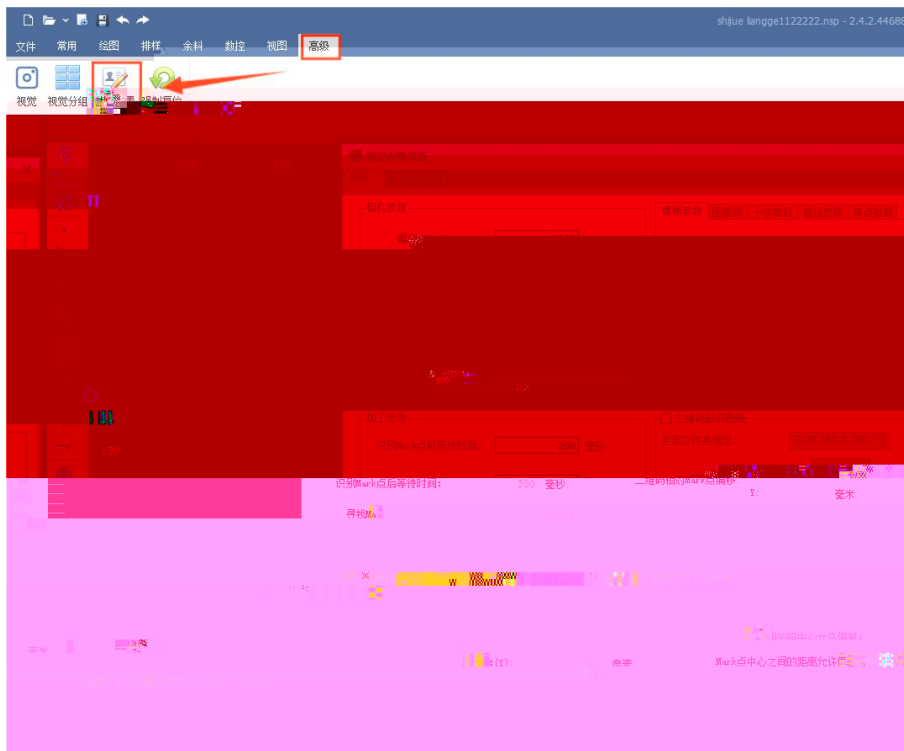

e

90° X
-90°

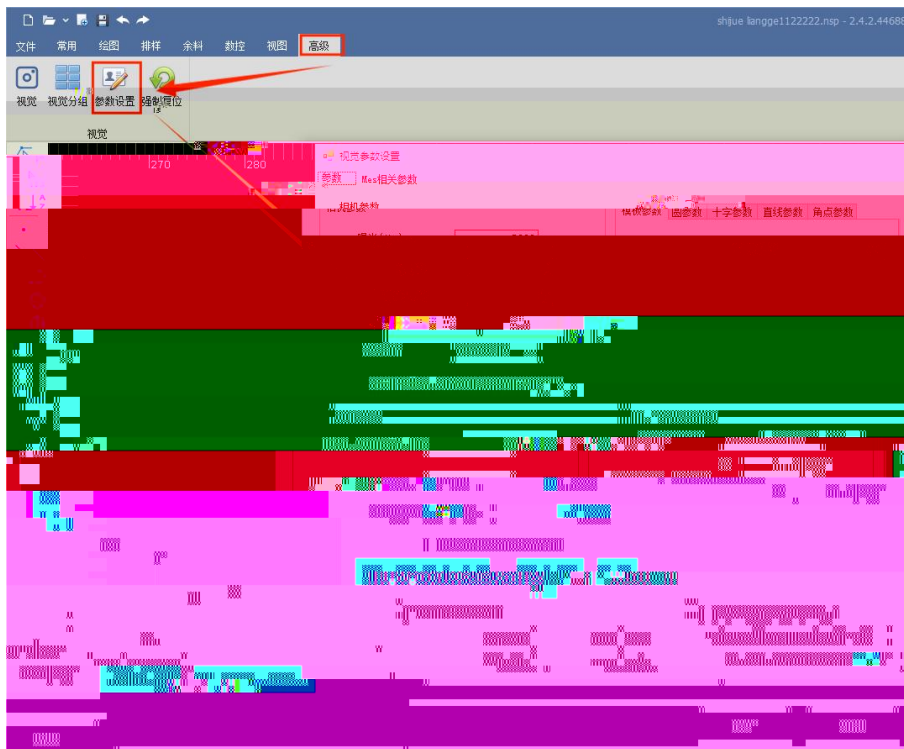

f

g
OPro Vi si on

3.3

- 1
- 2)

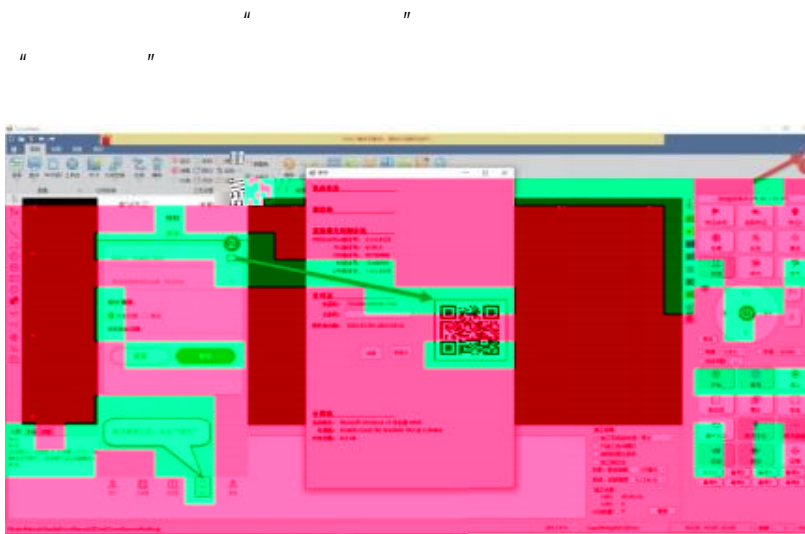

- 3)
- 4 " "
- 5) " "
- 6 " "



4.

4006701510

RAYTOOLS



4.1.

1 XY
XY
XY

XY XY XY



2 XY
XY

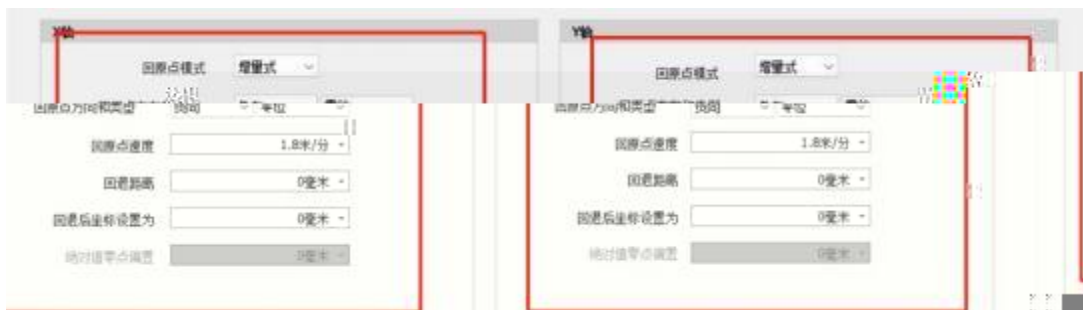

3 Z



4



5



6

7



4.2

1 HM

- -IO

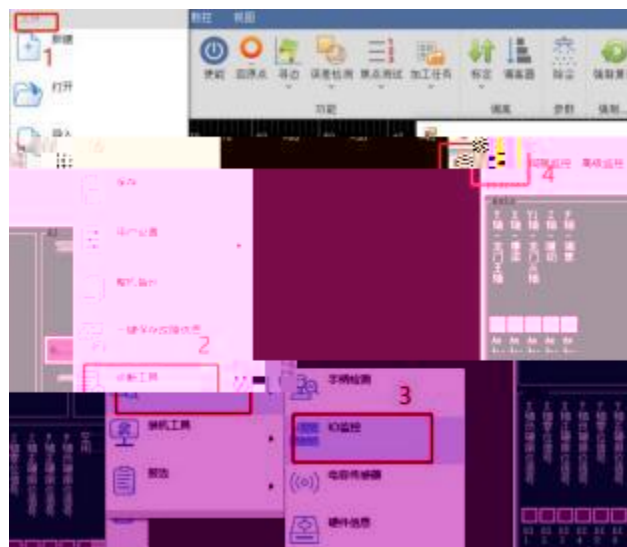

2



5.

4006701510

5.1.

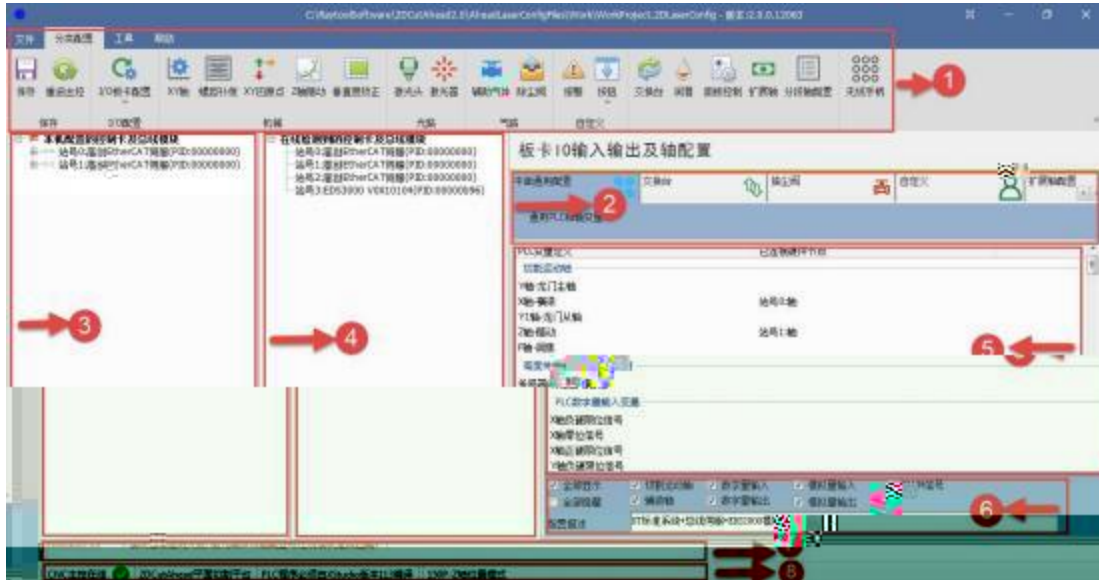

1 PLC 2 PLC 3 4 5 PLC
 6 PLC 7 8

5.1.1.







XY

7.4.3

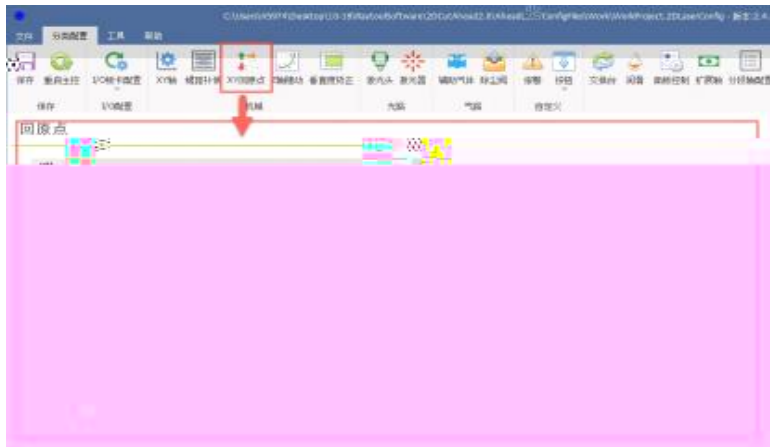

Z

Z

7.4.4

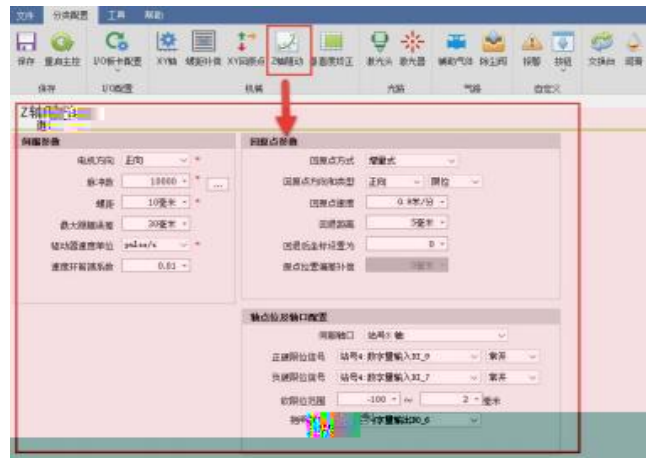

7.4.5 :



7.4.6



7.4.7

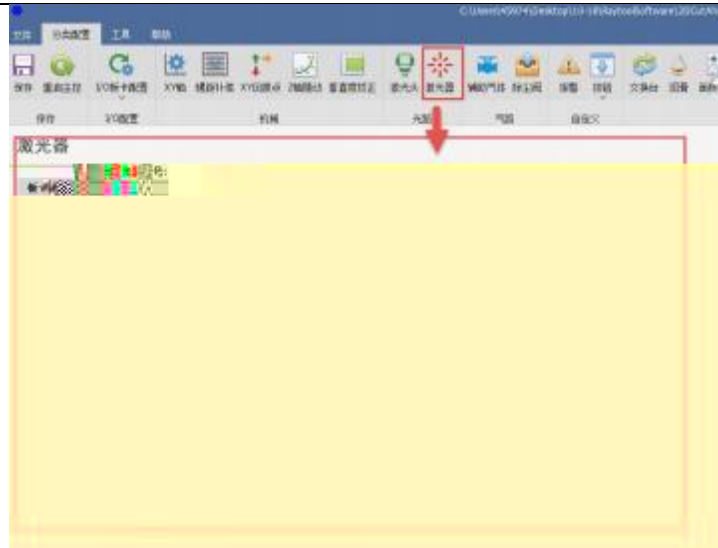

7. 4. 8



7. 4. 9

RAYTOOLS

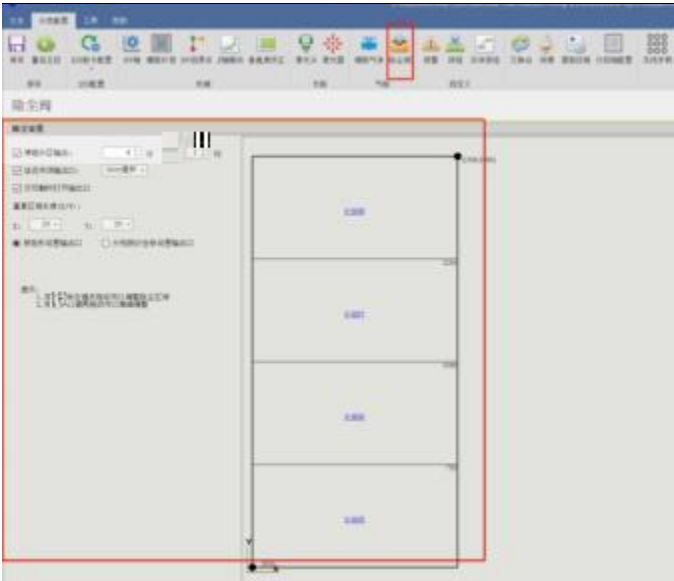

1-16

7. 4. 10

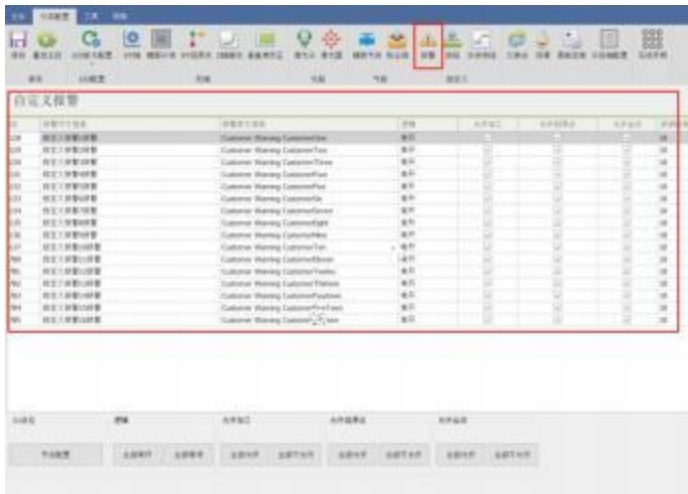

7. 4. 11



7. 4. 12

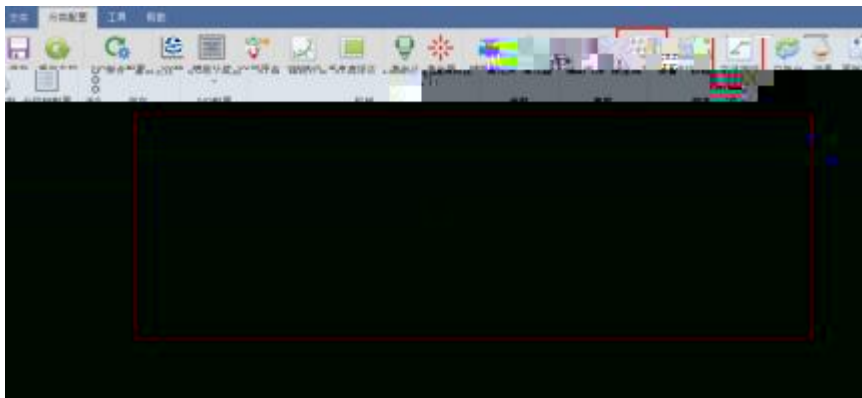

7. 4. 13

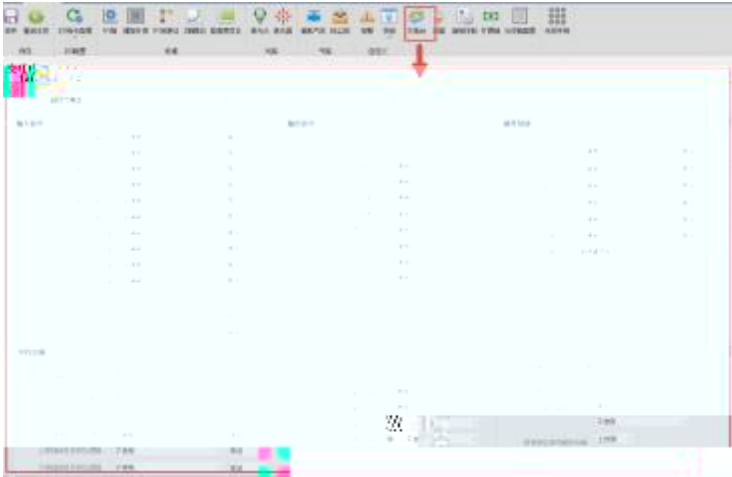

7. 4. 14



1.

RAYTOOLS

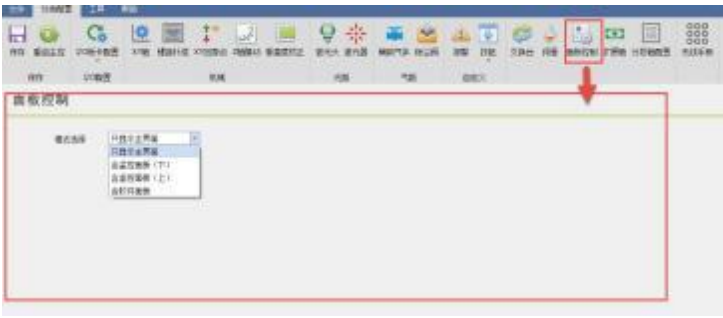

2.



3.

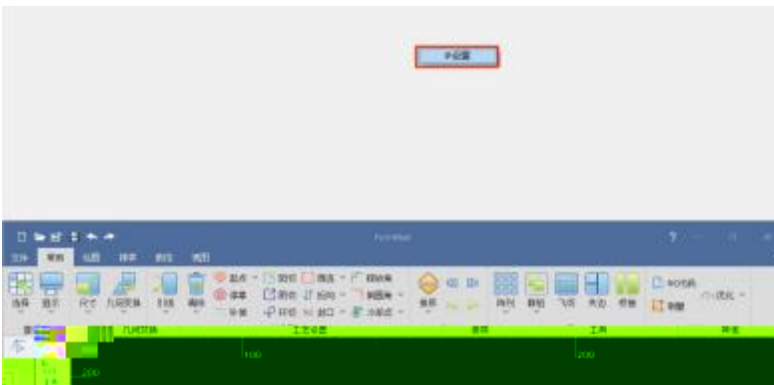

4.

IP

RAYTOOLS



C V B

7. 4. 15

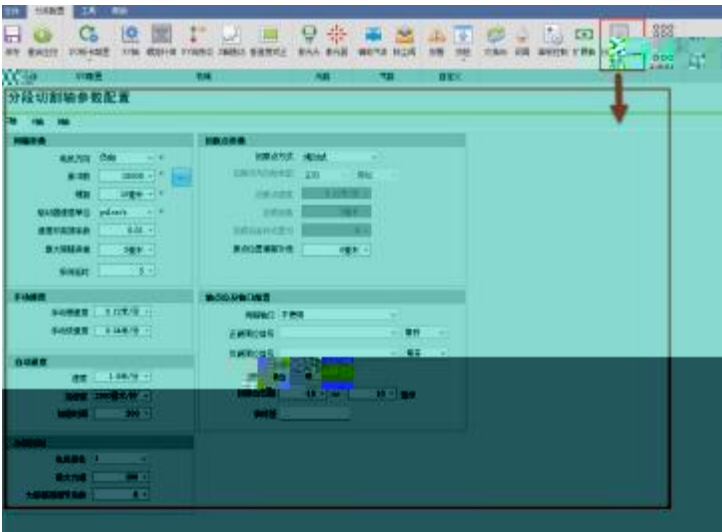

K1~K4 Fn+K1~K4 8

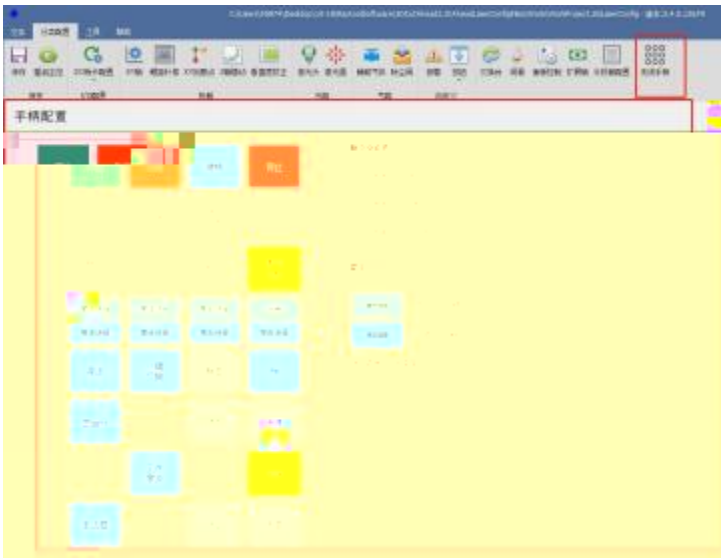

7. 4. 16





5.1.2 PLC PLC



PLC

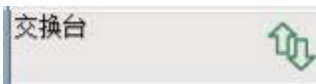

PLC

RAYTOOL

自定义

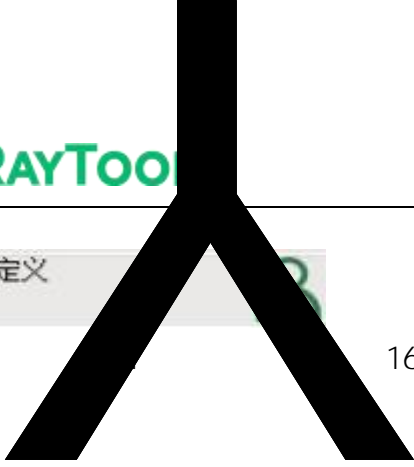

16

Â

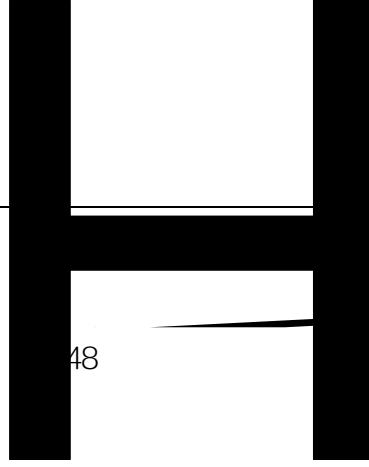

48

10

E

RAYTOOLS



2



1

- EtherCAT -

RAYTOOLS

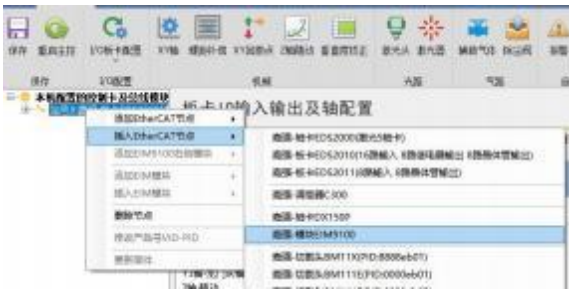

2



1

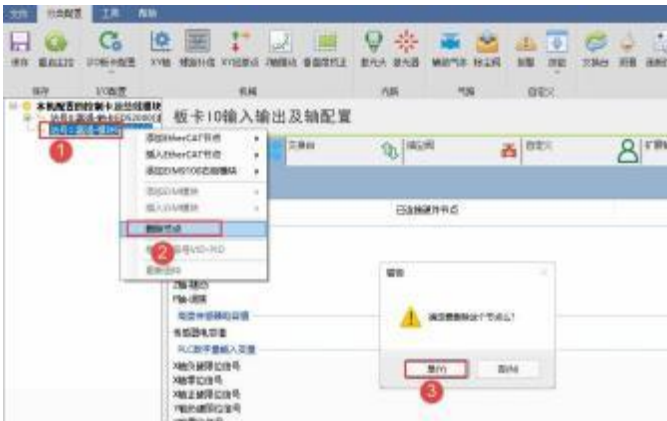

2



RAYTOOLS

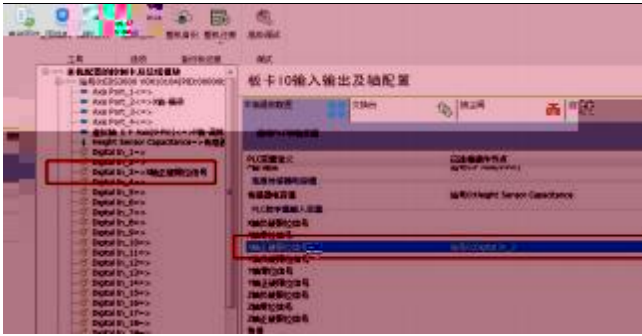

1

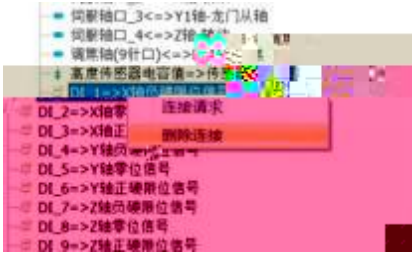

2

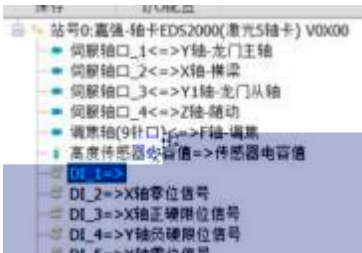

1

PLC

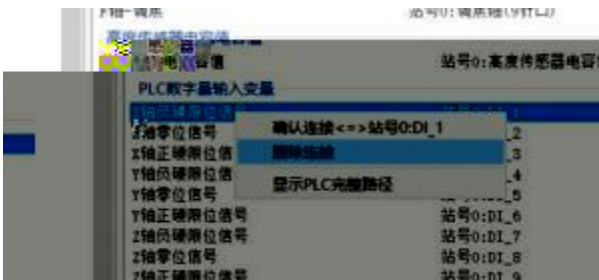

2



RAY

5.3

1

4

XC3000P

Position

X, Y1, Z

EDS3000

4006701510

XC3000S

EDS3000

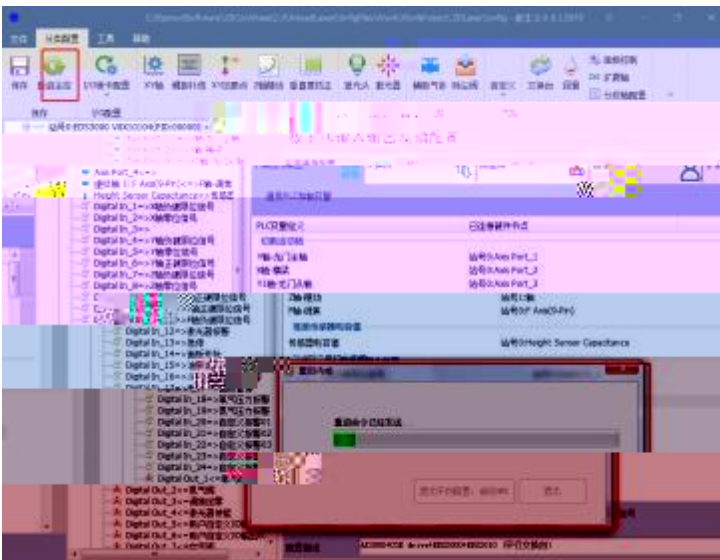

1

4

Y X Y1 Z
Y X

EDS3000

1 4006701510 4 EDS3000

4.2.1



2 0 Y 1 X
2 Y1 3 1 Z

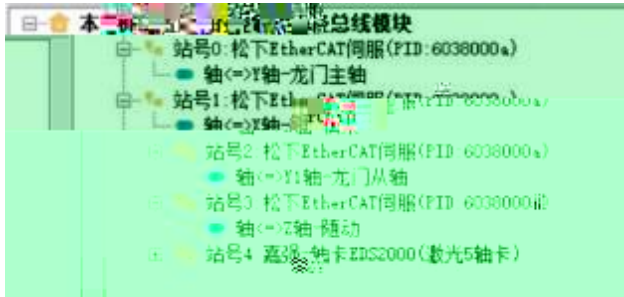

3 EDS3000

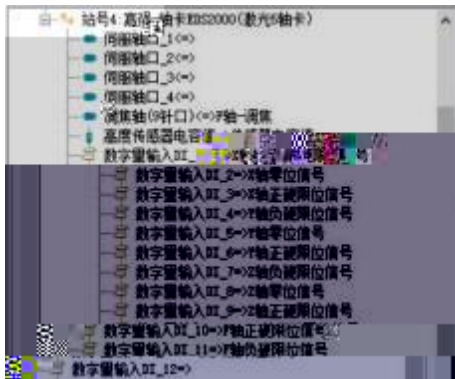

RAYTOOLS

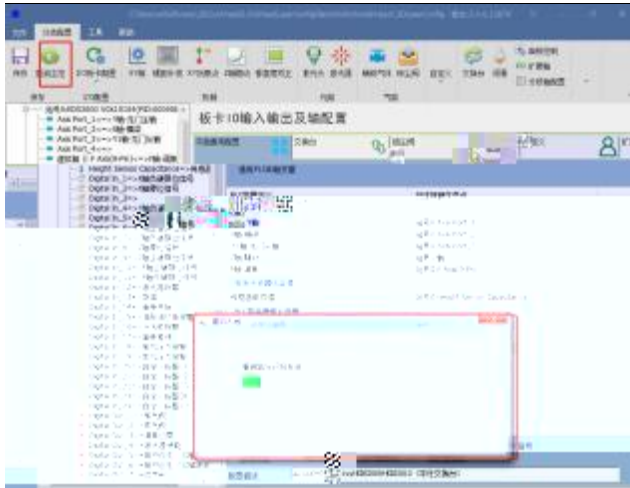

6.

6.1.

6.1.1.

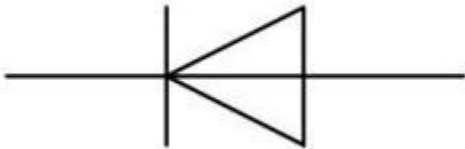

MC 6A10

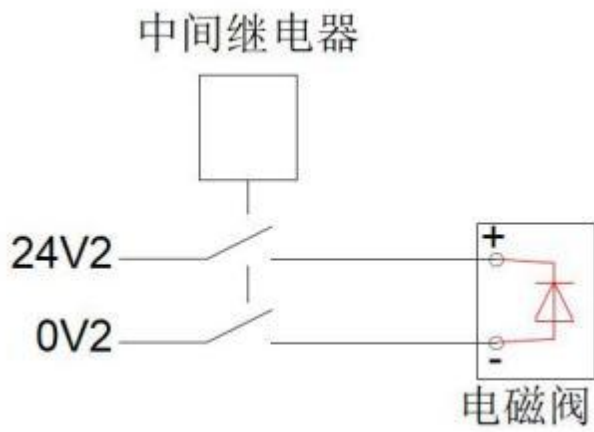

24V

0V

24V

0V

RAYTOOLS

1. 220V
DC12V
- 2.
- 3.

OneKEY

6.3.2

OP

1. 1.2
- 2.

6.3.3

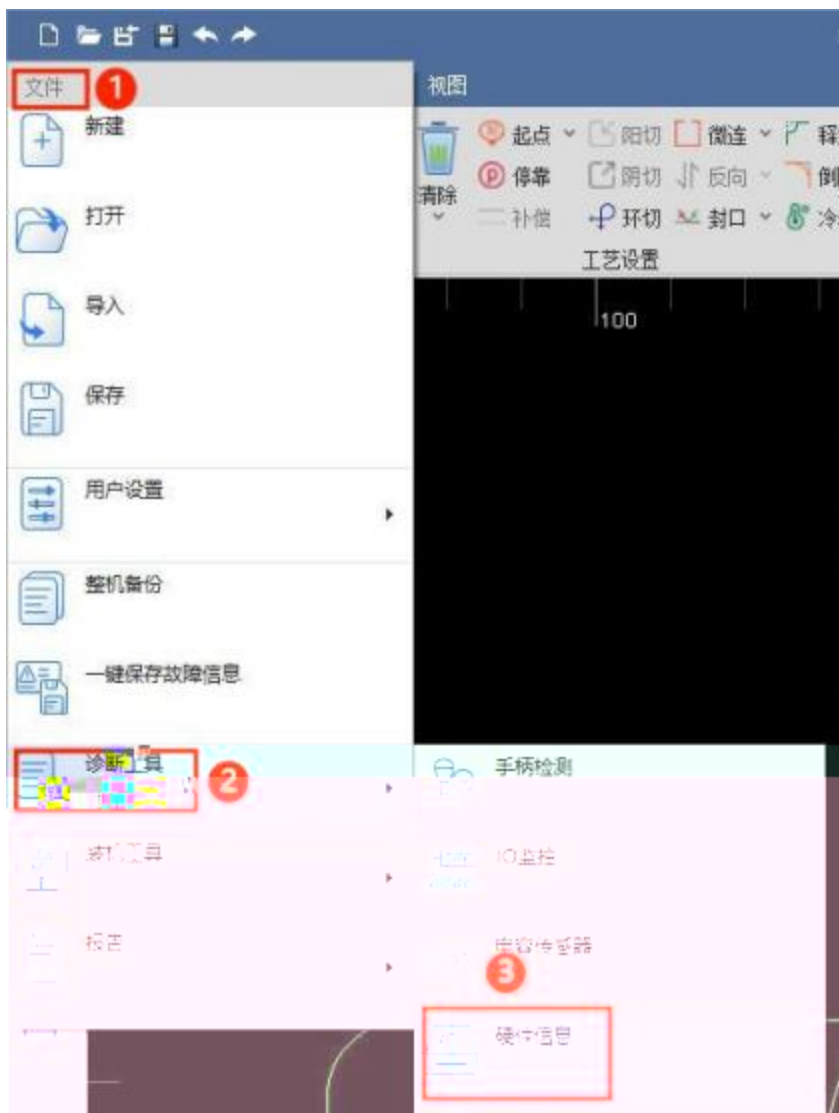

FormHardware

从站地址	从站名称	OpCRC	P0-Crc	P0-PHY	P1-Crc	P1-PHY	P2-Crc	P2-PHY
0	COHD	OP	0	0	0	0		
1	COHD	OP	0	0	0	0		
2	SGD75-xxxx0x	OP	0	0	0	0		
3	EDS3008	OP	0	0	0	0		

Master0

Phase: Operation

Active: yes

Slaves: 4

Library: ...

Master: ... (attached)

Link: OP

Tx frames: 174660677

Tx bytes: 64361193748

Rx frames: 174669876

Rx bytes: 64361193421

...

地址

地址

OP

OP

P0-Crc

P0-PHY

RAYTOOLS

EtherCAT	2 LINK	EtherCAT			

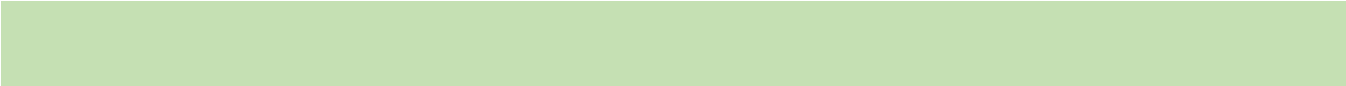

7.

7.1. EDS2000

XC3000Pro Vi si on

EDS2000

EDS3000

EDS2000

7.1.1. EDS2000I /O

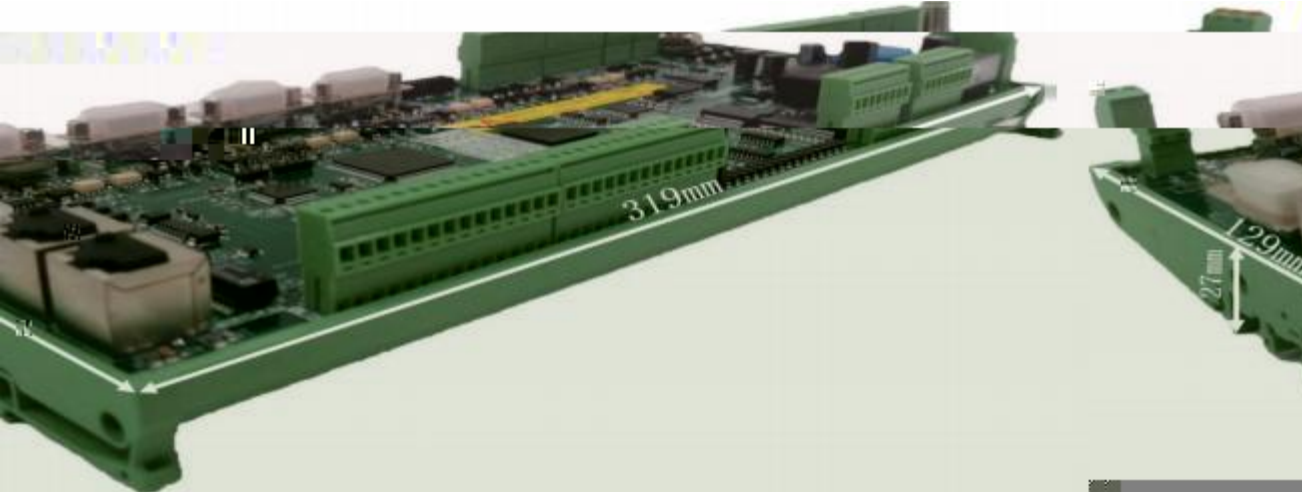

EDS2000

EtherCAT

I O

7.1.3 EDS2000

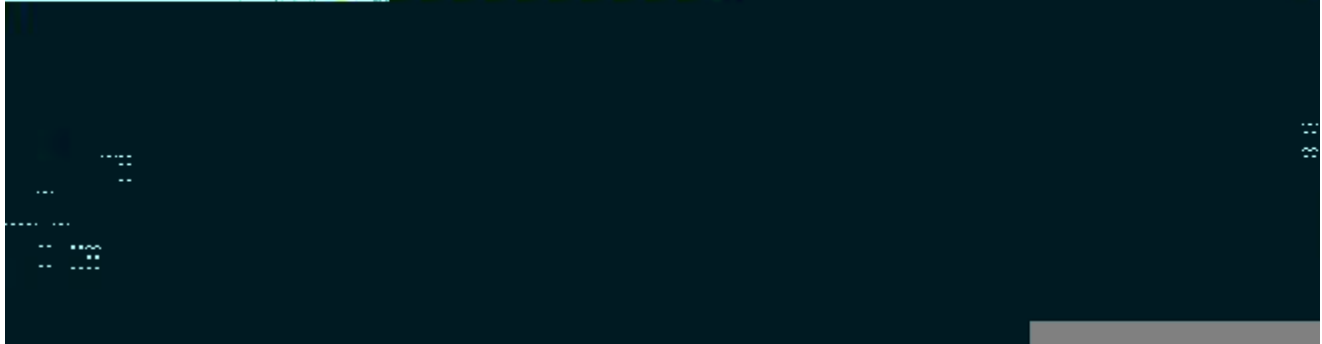
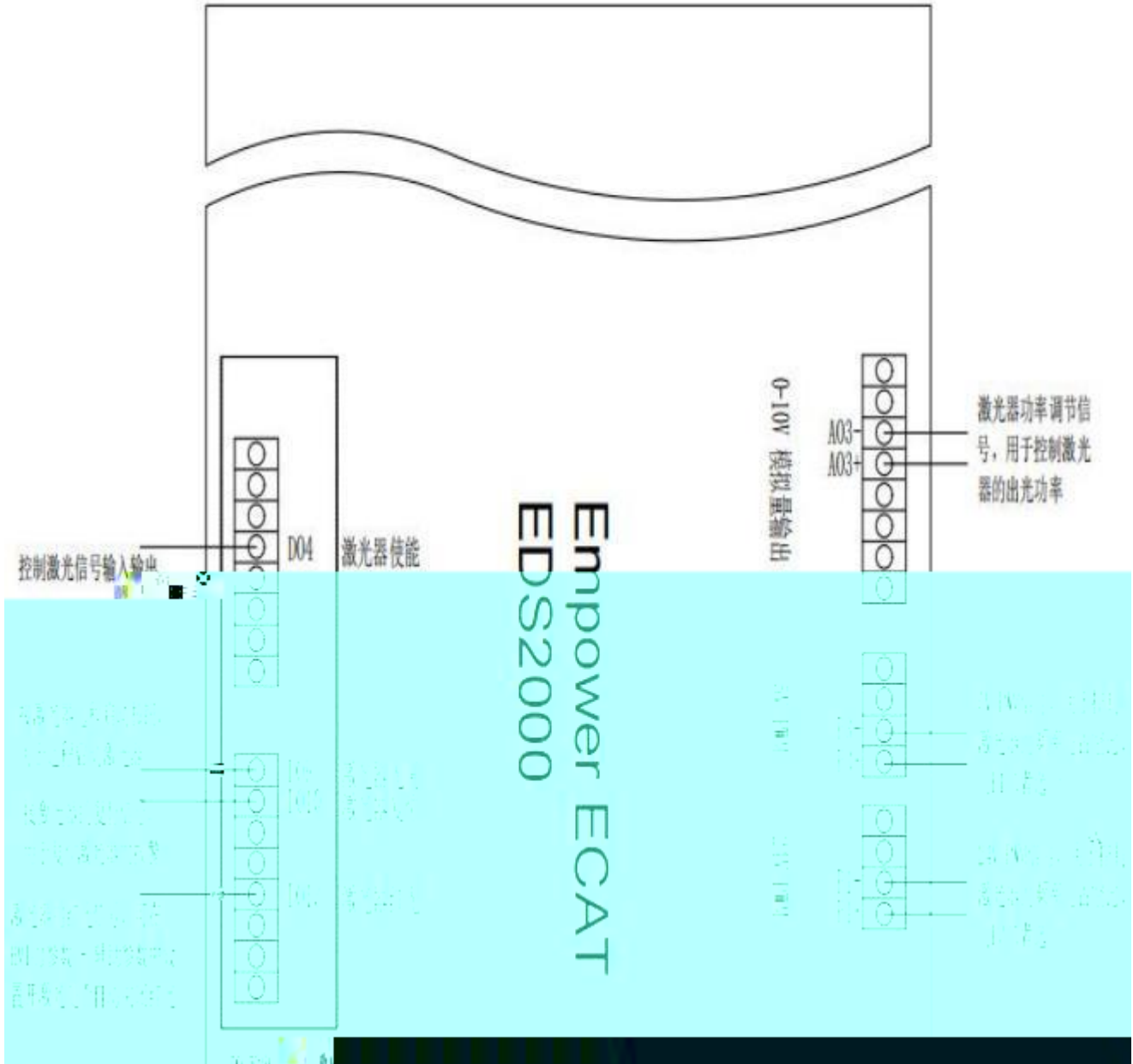

F					
1	CLR		6	SON	
2	ALM		7	PP	+
3	NP	-	8	ND	-
4	PD	+	9	PGND	
5	P24V	24V			

EDS2000

SON

ALM

OV

OV

3

EDS2000

+

SON

24V

ON

ALM

24V

ON

"

"

F

B

A2

7.1.5 ·

rw 1 v

Pr001	0	0	1:
Pr007	3	3	
Pr005	1	1:	3mpa; 0: 500kpps

B

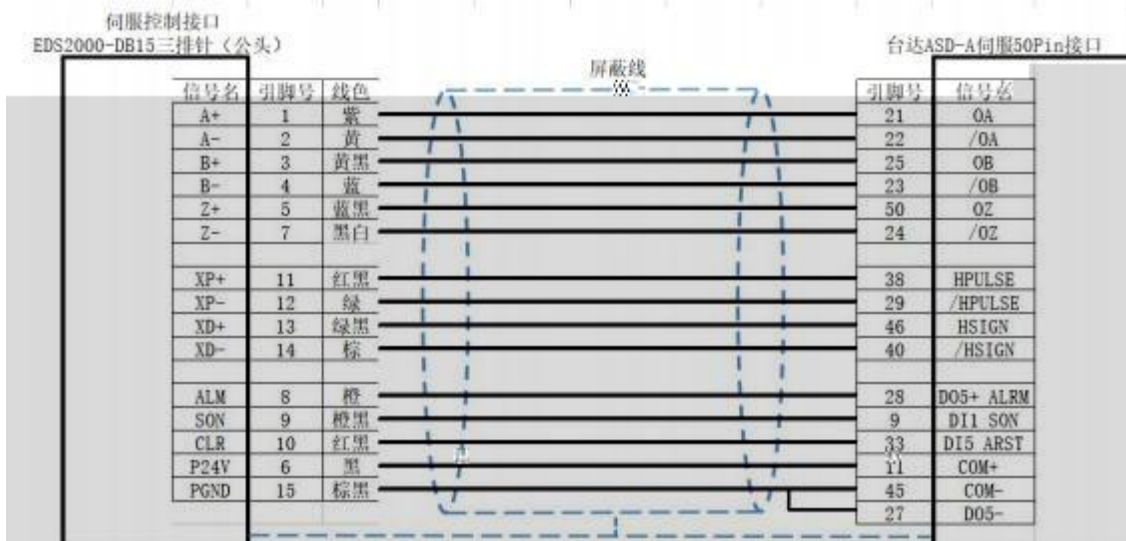
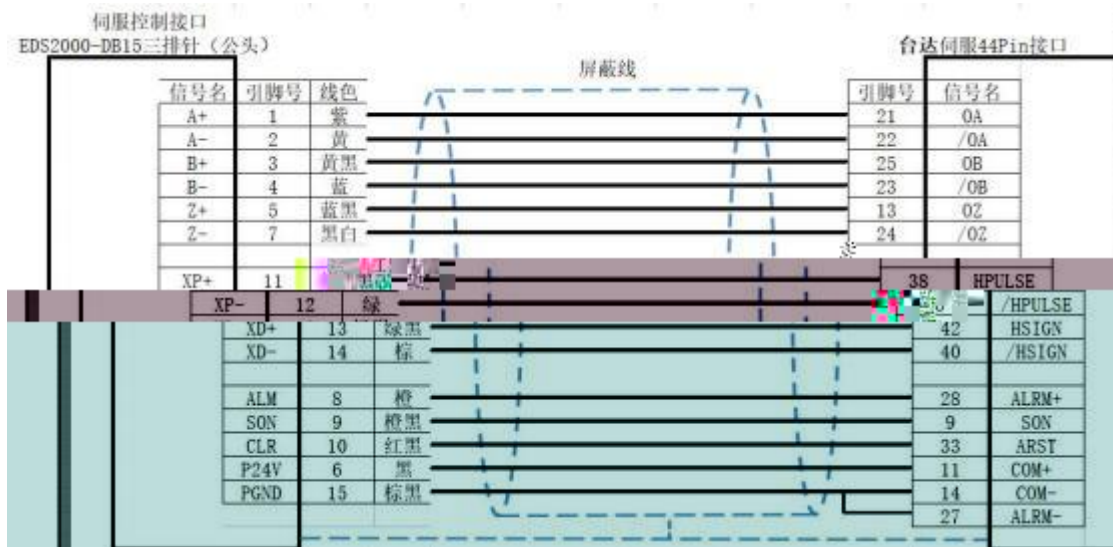

P1-00	0x1002	1
P1-01	0x0000	1
P2-10	0x0101	DI 1

ALPHA5 Smart

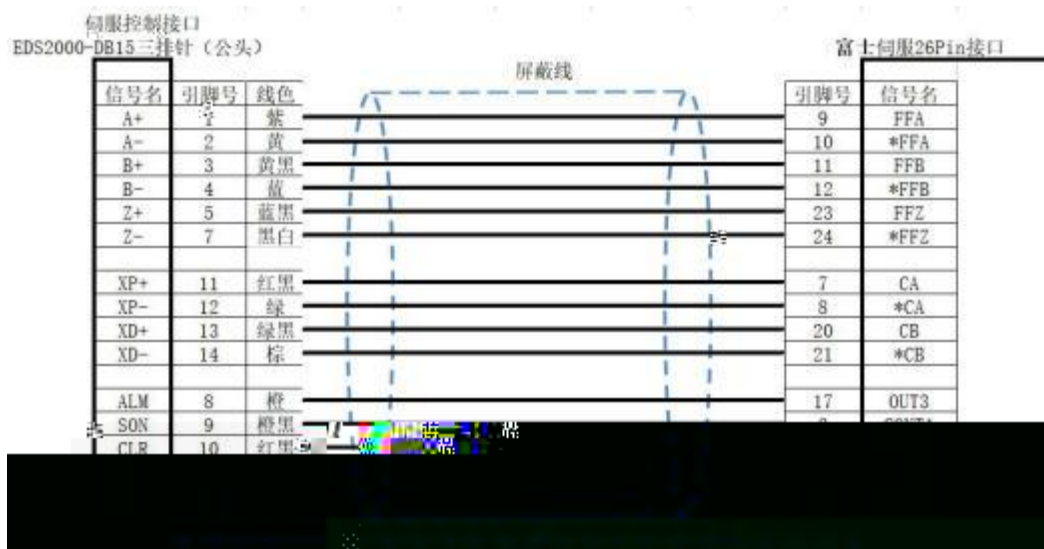

PA-101 0 0... 1... 2... 3... < = > 4...
 < = > 5... < = > 6... 7...

PA-103 1 0... : / 1... :

		12...	: 90°	2
--	--	-------	-------	---

F



7.3. EDS2011

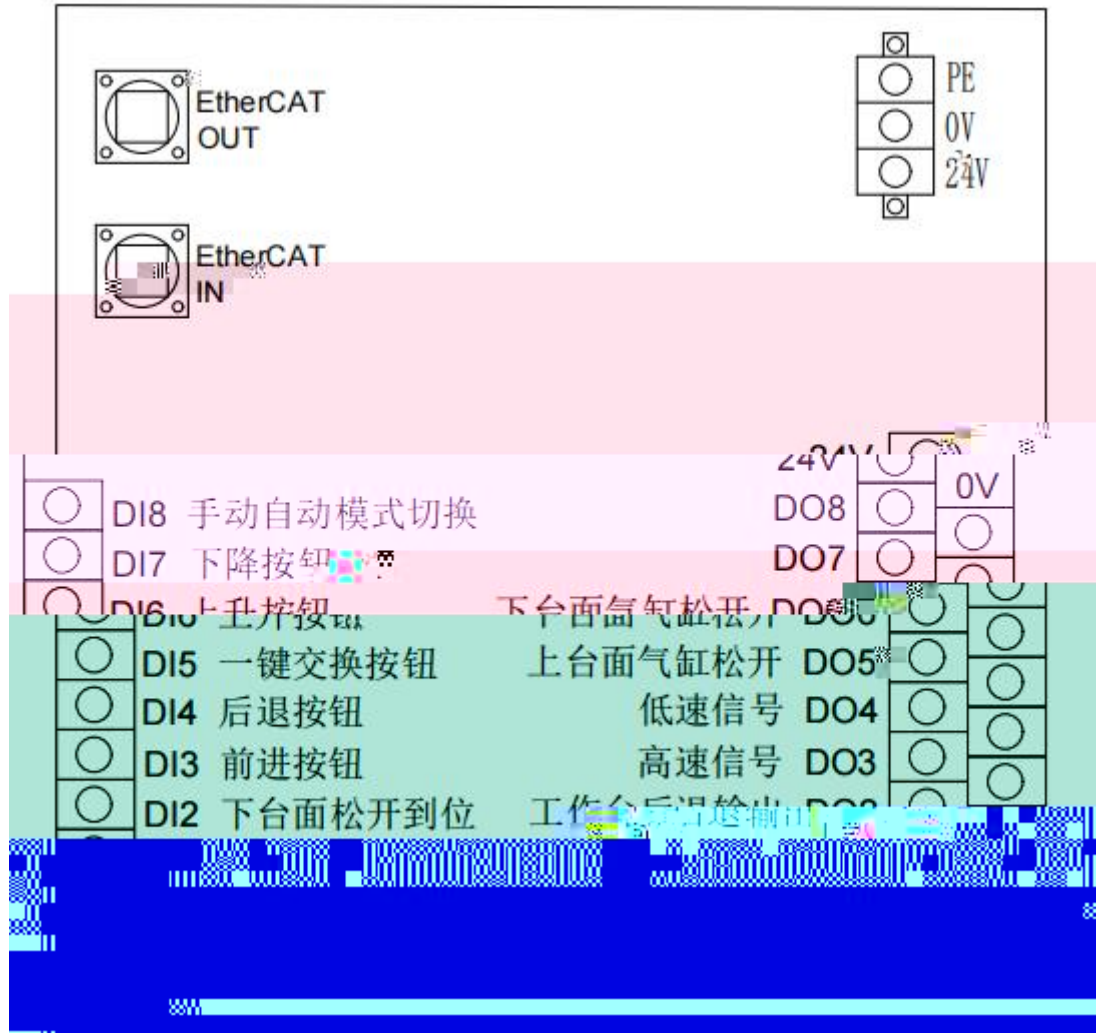

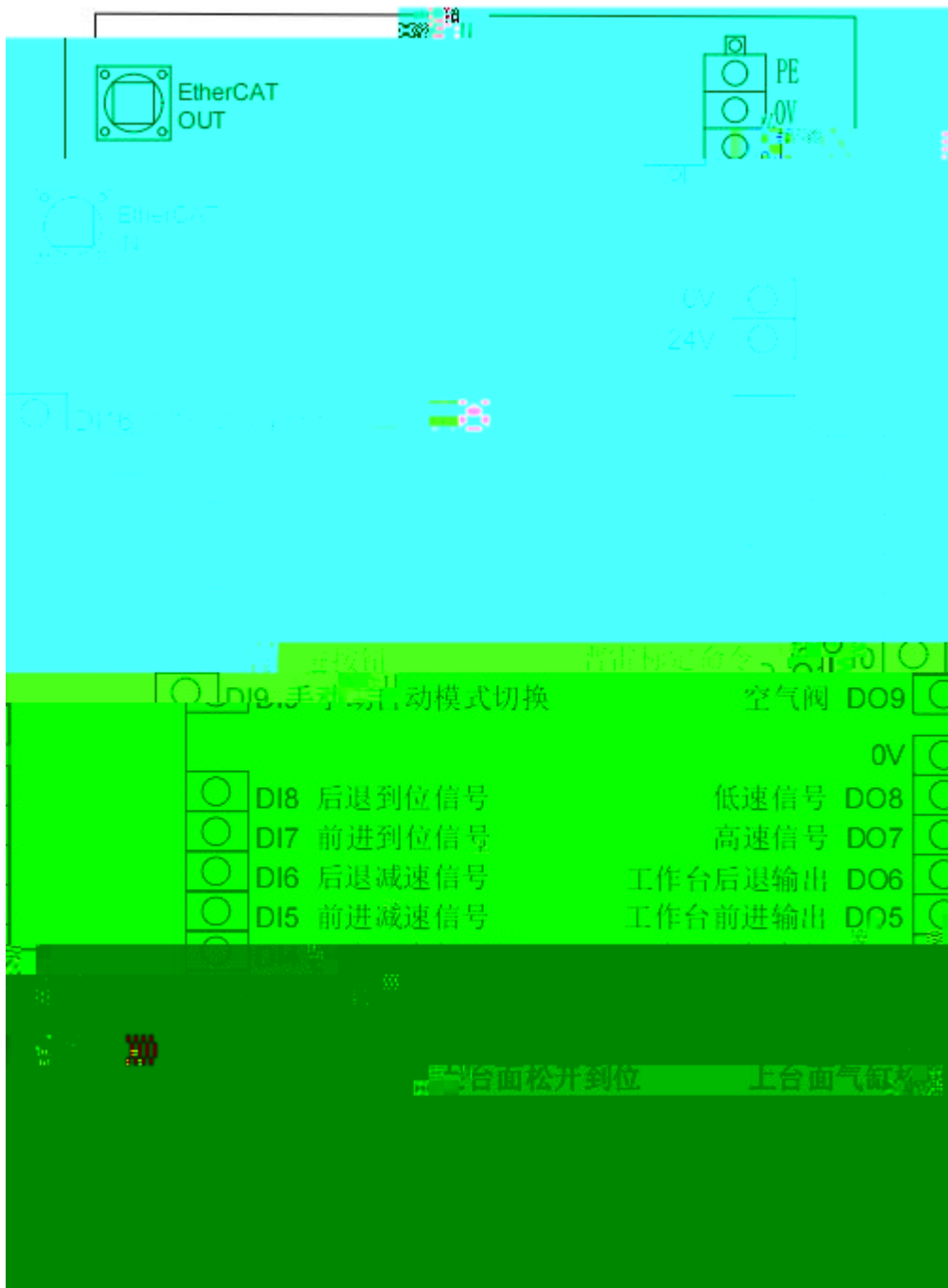

7. 5. EPC- 2000

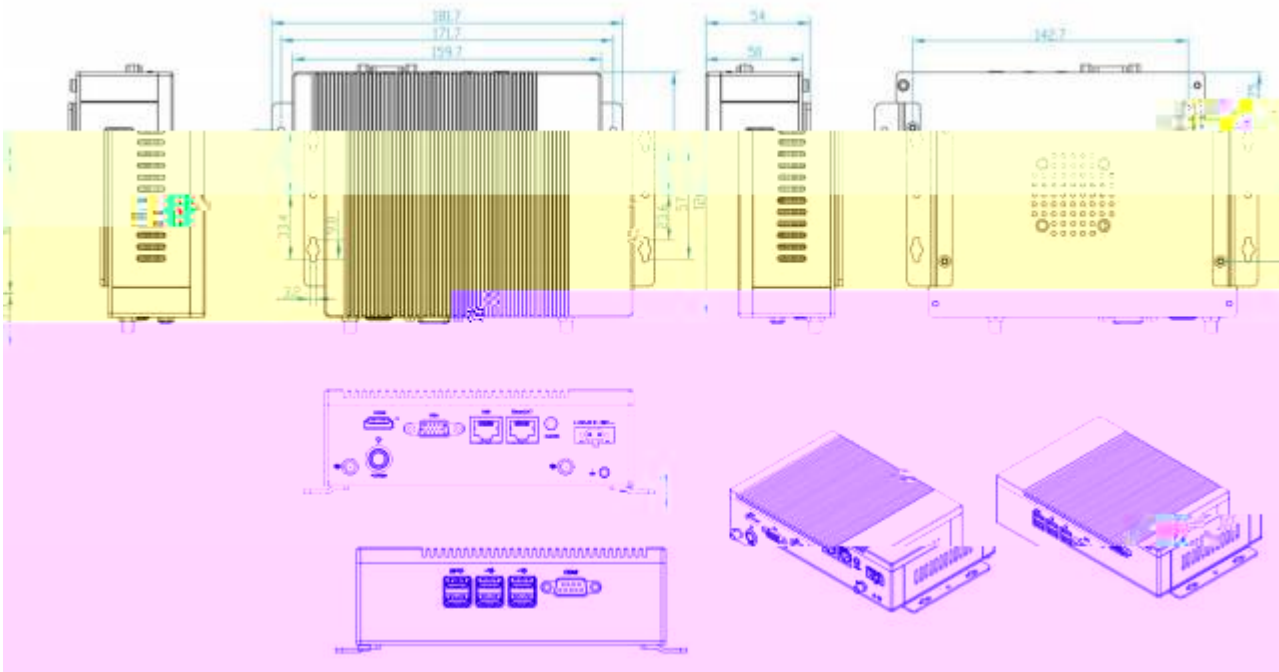

7. 6. EPC- 1020

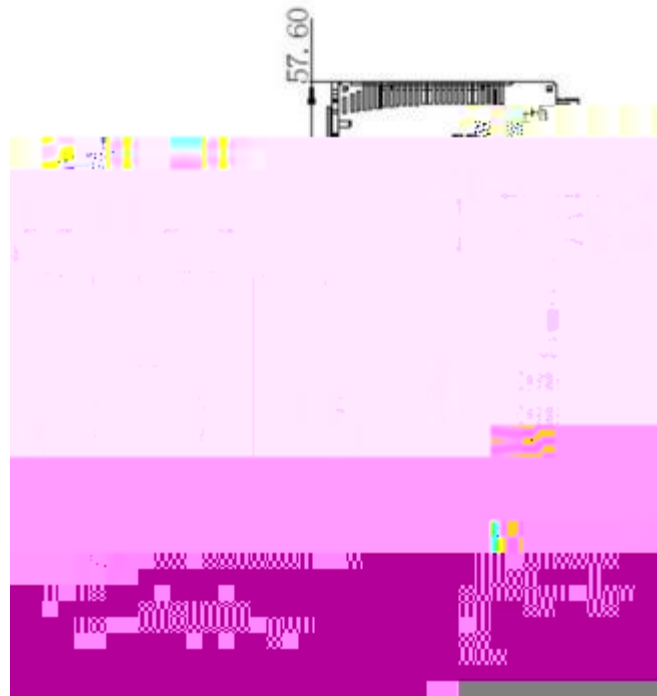

7. 7. I PC E4000

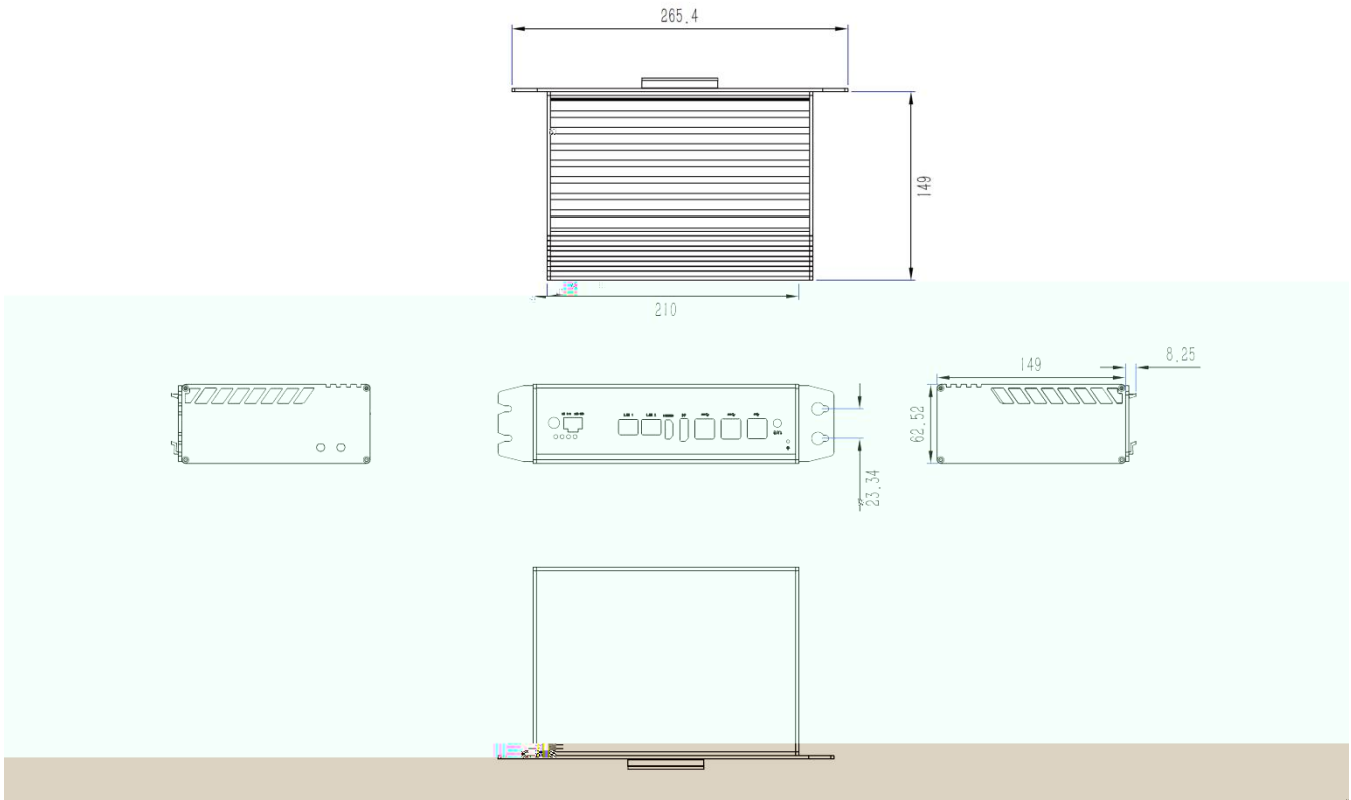

7.8

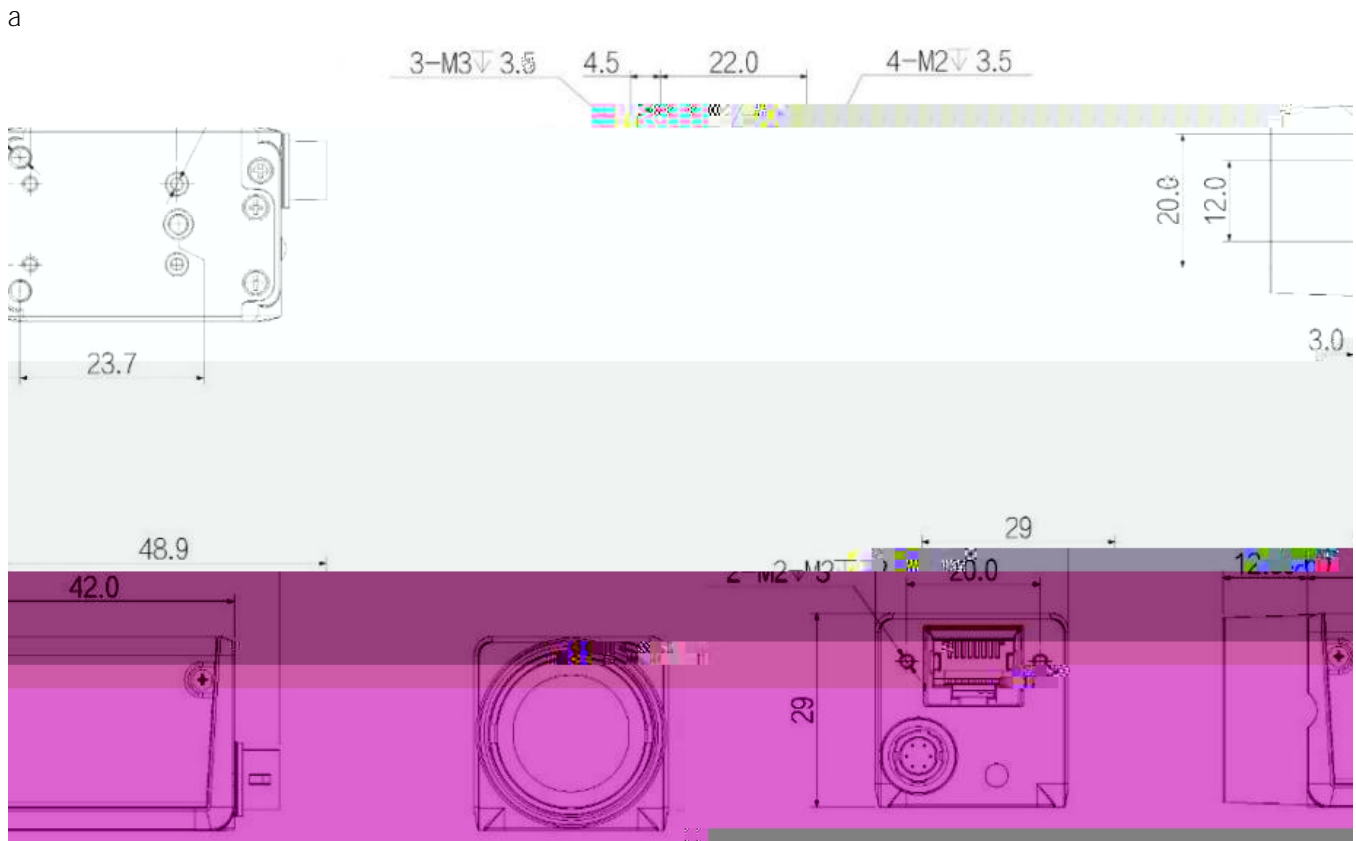

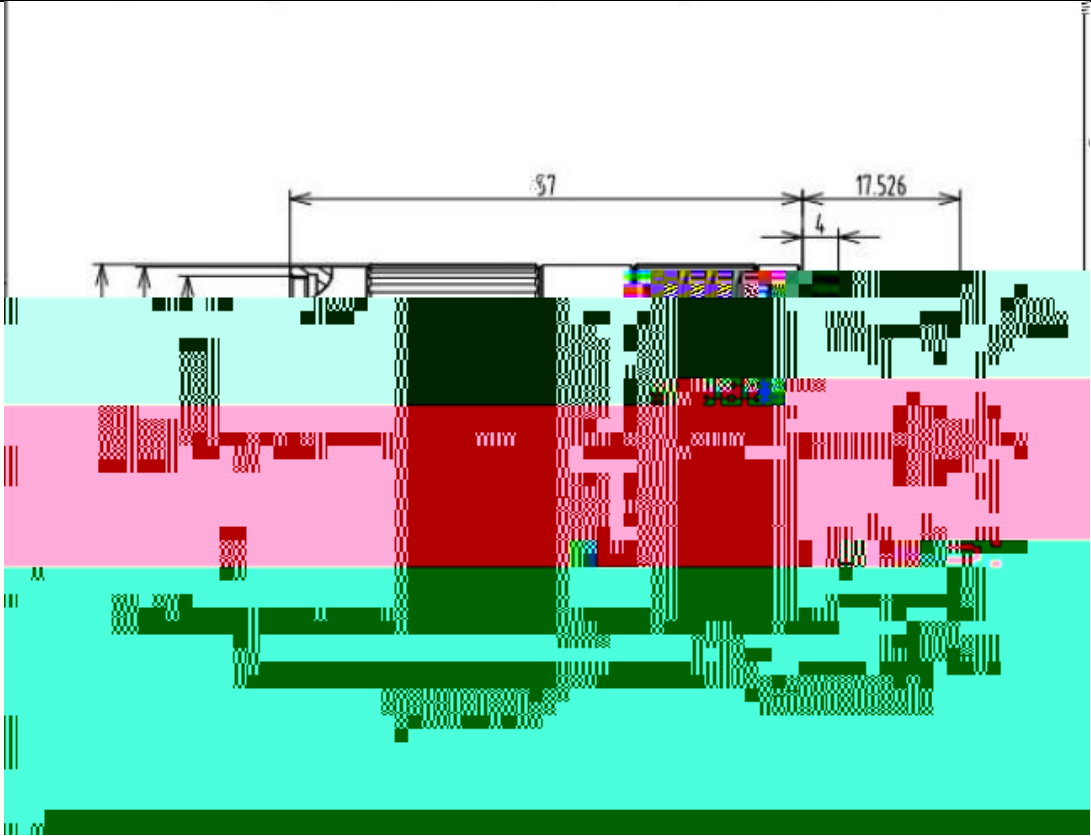

C

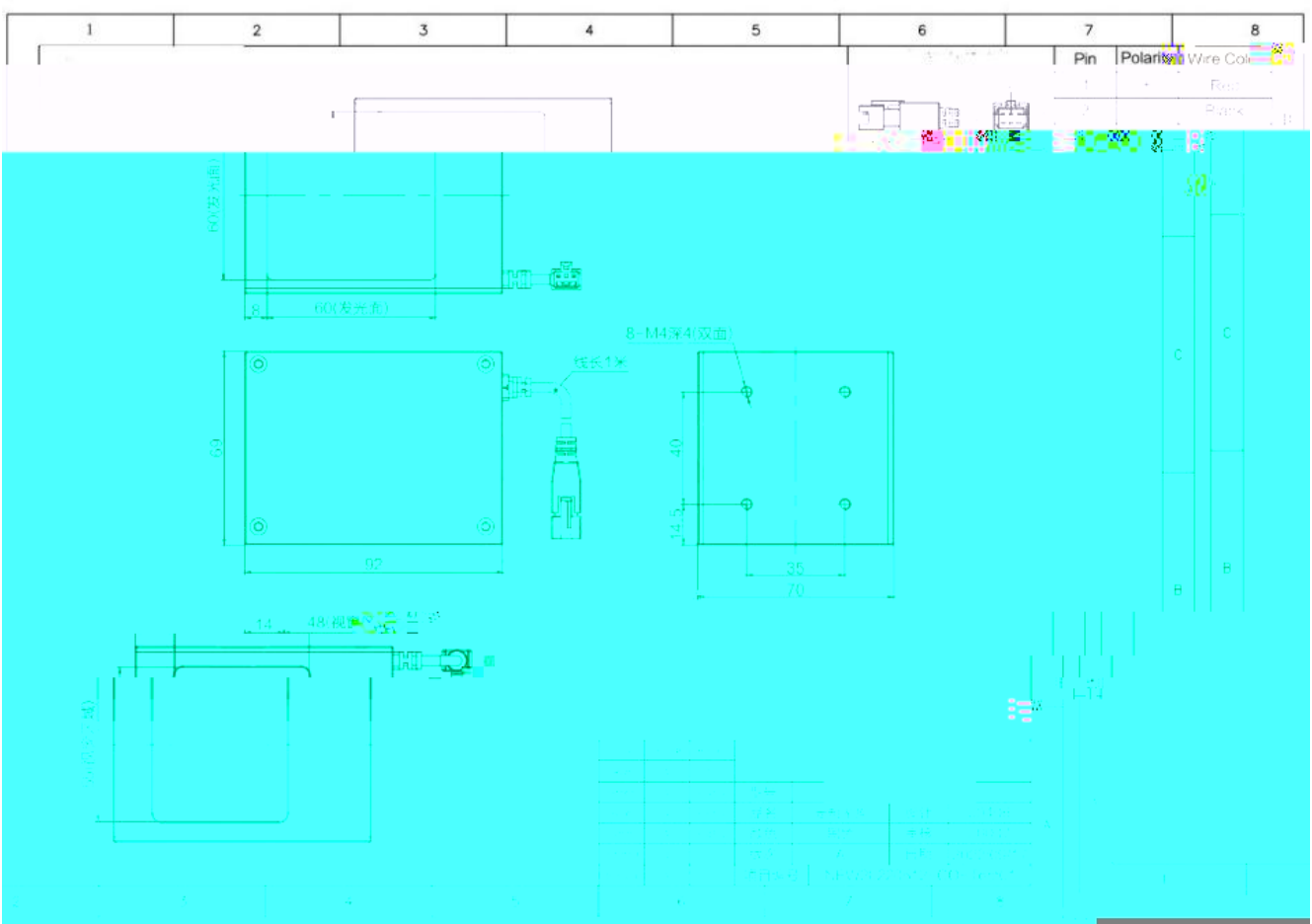

d

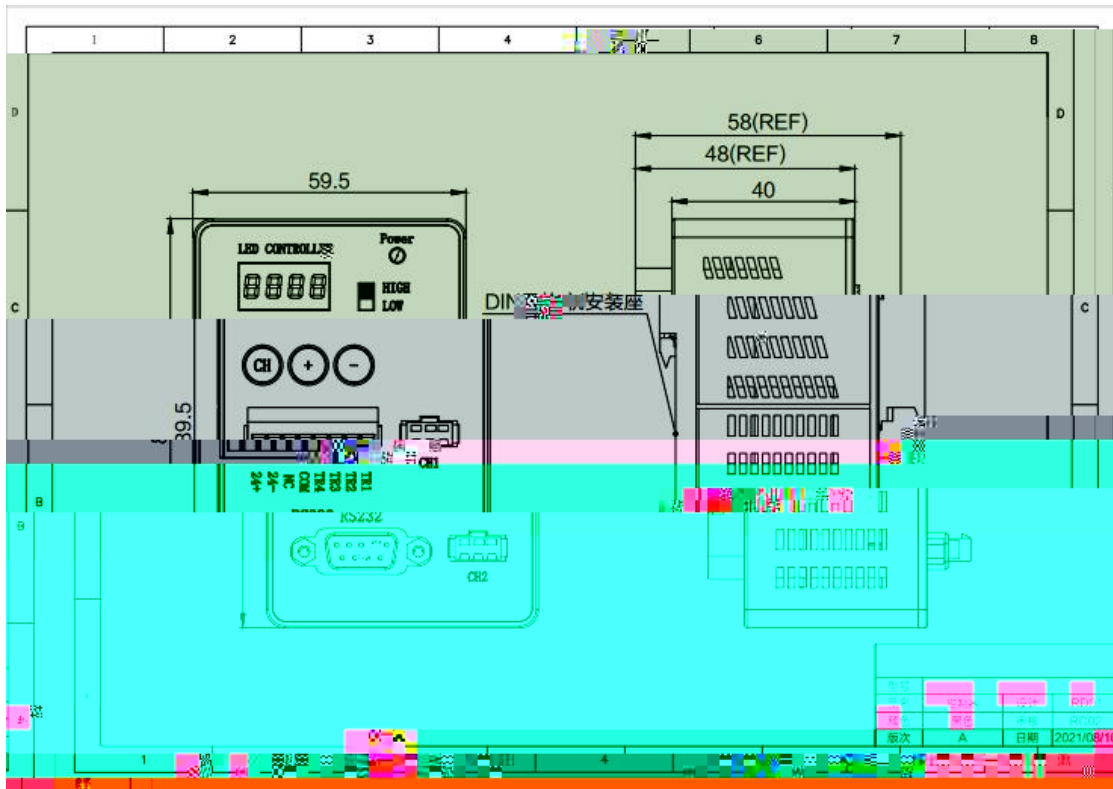

7.9.

7.9.1. XY

XY

10000

CW CCW

36

0

60

60

6000

X

Y

X

Y

Y

X

Y

X

X

Y

DI 3/DI 6

/

X/Y

DI 2/DI 5

/

X/Y

DI 2/DI 4

/

X/Y

Y1		
		Y1
	10	
	0	
	1	

7.9.2

7.9.3 XY

XY		
		0
	1.8	
	0	
	0	
	0	

7.9.4 Z

Z		
	10000	
		CW CCW
	10	
	pul se/s	pul se/s 0.1RPM RPM
	0.01	
	30	
		0
	0.9	
	5	
	0	
	0	
	DI 9	
	DI 7	
	-100~2	Z
	DI 6	

7.9.8

D09

10 0-10BAR

7.9.9.

/	4/1	
	Do5- Do8	
X/Y	20/20	
	1500* 3000	

7.9.10.

ID	1	2	3.....

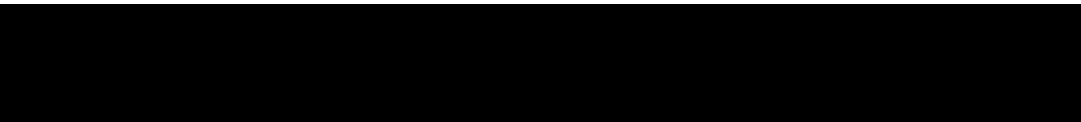



WNOCE

RETOURS



RAYTOOLS

Z	0	Z
Z		Z (Z-
		Z-

7.9.14.

7.9.15.

	CW	CCW
10000		
10		
pul se/s	pul se/s	0.1RPM RPM
0.01		
5mm		
5		
0.12m/ni n		
0.24m/ni n		
1.8m/ni n		
2000mm/s		
500		
1		
200		
0		

0

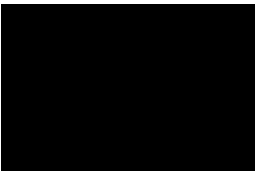

7.9.16

HM		
GOO		

